



# MAGNETIC SOLUTIONS

## LIFTING • CLAMPING • TOOLS





**FX Permanent Lifting Magnets,**  
Page 5 - 11



**FX-HV Verticalsystem,**  
Page 12



**FXE Electro-Permanent Lifting Magnets,** Page 24-40



**Electro Collecting-Magnets,**  
Page 50-51



**Battery Lifting Magnets,**  
Page 52 - 53



**Crane Scales, Load Limiter,**  
Page 54 - 58

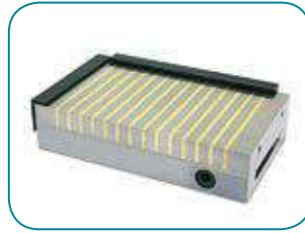

**Permanent Magnetic Chucks,**  
Page 69 - 73



**Sine Tables with Magnetic Chucks,** Page 74 - 77



**Electro Magnetic Chucks,**  
Page 78 - 83



**Electro-Permanent Magnetic Clamping Systems,** Page 84 - 100



**Palettizing Magnetic Chucks and Changing Systems,** Page 101 - 112



**Magnetic Circular Chucks,**  
Page 113 - 121



**Lamella Plates and -Blocks,**  
Page 122- 124



**Magnetic Block and -Prisms,**  
Page 125 - 130



**Magnetic Clamping Balls,**  
Page 133 - 135



**MBX Magnetic Blocks,**  
Page 136 - 137



**Magnetic Bases, Statives,**  
Page 138



**Terrain Cleaing Magnets,**  
Page 139 - 141



**Spreading and Protective Magnets,**  
Page 142 - 144



**Magnetic Tools,**  
Page 145 - 146



**Magnetic Bars and Roundmagnets,**  
Page 153 - 156



**Permanent Flat- and Rod gripper,**  
Page 157 - 172



**Permanent Raw Magnets,**  
Page 173 - 176



**Demagnetizer, Measuring Devices,** Page 178 - 181

Page 4 - 67



Magnetic Lifting

Page 68 - 131



Magnetic Clamping

Page 132 - 151



Magnetic Tools

Page 152 - 176



Magnetic Holding and Gripping

Page 177



Accessories

## Lifting Magnets

Lifting magnets are the perfect load suspension device for anyone who needs to work quickly and safely. A multitude of advantages speak for their use wherever loads have to hold without a handle. Use the material storage, transportation, fixture and during loading and unloading of machines.

We carry a wide range of different types and technical concepts, from broadband applicable standard product to the individual specialty magnets for bulky parts.

Please note the technical information on pages 59-67 in the catalog when selecting lifting magnets.

Any information relating to holding power in the chapter „Lifting magnets“ were, in accordance with the test procedures for Lifting magnets smaller in EN 13155 at a test plate of low carbon steel, suitable thickness and flatness 0.1 / 500 mm determined.

For specific handling problems we can advise you.

**Page 5 - 23**



Permanent Lifting Magnets,  
Horizontal-Vertical Lifting System,  
Permanent Magnetic Truss

**Page 24 - 37**



Electro-Permanent Lifting Magnets

**Page 34 - 35**



Electro-Permanent Magnetic Trusses

**Page 38 - 40**



Electro-Permanent Lifting Magnets  
with MCF Control Unit

**Page 46 - 49**



Heavy Lifting up to 30 t

**Page 50 - 51**



Electro-Excavation Magnets

**Page 54 - 58**



Load Measuring

**Page 59 - 67**

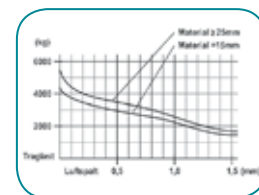

Technical Basics,  
Selection aid Lifting Magnets,  
Load Tables FX, PML, FBM

FX-Lift is the product line has been developed according to the needs of users



## Permanent Lifting Magnets



The FX base unit is suitable for flat and round material



FX-R - suitable if you mostly lift round and/or hot material



FX-P - when it comes to plates below 12mm thickness and pipes - the right device for the laser cutting system



FX-V - Especially suitable for sections, beams and hot parts 150°C/100%



FX-HV - especially for the horizontal and vertical transport



FX-LT - light beam with 2-strand chain for sheet metal and workpieces with Centric Cutout



## Electro-Permanent Lifting Magnets



FXE 50 - for plates from 4mm and workpieces with a small air gap



FXE-L 50+ - long design with reinforced magnet system for tubes, beams and strips



FXE 80 - for lifting sheets from 8mm; for massive parts with medium air gap



FXE 100 - for heavy plates, forgings, ingots



FXE-R - for round and flat material also in layers



FXE-Z - with special demagnetizing



FXE-T - electro-permanent magnet trusses for sheet metal



FXE-M - modular system for the construction of trusses or for Pick & Place Systems

## Magnetic Lifting

FX lifting magnets are the new innovative product in the field of magnetic lifting technology. They work with a single- magnet system consisting of high-energy magnets half-shell, which can be fully activated in only 90° Switching travel, and works completely non-rebound and self-locking. The massive, ball-bearing switch shaft with the half-shell structured magnet has no magnetic Losses due to internal short circuit and can be manufactured in one piece in the entire length without welds or tapered transitions, and without millings for Block magnets what makes them virtually indestructible.

The unique, patent-pending design with half-shell magnets and Reduction of the inner air gap in the magnet system ensure a considerably higher performance by using the same amount of magnetic material - which reduces costs and protects the environment.



**Green Magnets for the modern Industry - Made in Germany**

Gefördert durch:  
  
Bundesministerium  
für Wirtschaft  
und Energie  
aufgrund eines Beschlusses  
des Deutschen Bundestages



# Exclusive Benefits of the FX-Series

## FX - Economically the right decision

- Made in Germany
- Standard-compliant and tested CE/EN 13155/MRL 2006/42 EWG
- Product liability insurance with a German insurance company
- Multilingual Documentation
- Environmentally friendly and future-proof by higher Power with lower SE Magnet consumption
- **3** years Warranty
- Safety factor **3,5**
- supply of spare parts guaranteed for **10** years
- CAD Data available

## FX - Technically the right decision

- 100% nickel
- High Energy half-shell Magnets
- actuator travel of only 90°
- large forged lifting eye (SF5)
- great performance in a compact design
- short loading- and unloading times
- no mechanical impairment of workpiece
- very massive shift shaft
- recoilless hand operation
- suitable for flat and round materials
- increased safety via simple operation

The large, forged lifting eye is accessible and is, in its load range, beyond the usual Hook sizes (SF5)

The safety groove at the end of the switch knob gives feedback of full lock



Anodic Type plate

The stable lever with one-handed switch mechanism in self-explanatory hand brake system is equipped with an ergonomic Handle of high PAH-free plastic provided he is well in hand and can be switched easily. Recoilless, self-locking

High energy magnets, ensures stable performance up to the maximum working temperature of 80°C in the magnetic core. Even at these high temperatures, the FX still reaches the norm required safety factor.

Monoblock solenoid shaft, made of one piece, fully plated, ball bearing without mechanical flaw

Massive stator-body manufactured from one piece, completely plated, for maximum corrosion protection

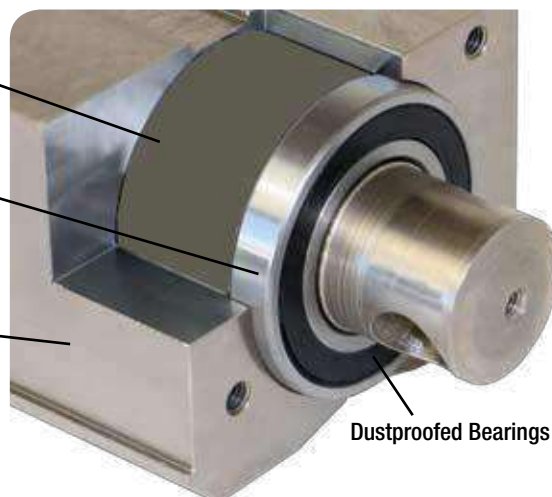

Dustproofed Bearings

## FX Universal Permanent Lifting Magnet

FX lifting magnets in standard version convince with their wide range of applications. The FX achieved good results at both, a large air gap as well as thin flat and round materials. It has a compact design and low Own weight. The device is characterized by great robustness and a very good price/performance ratio.

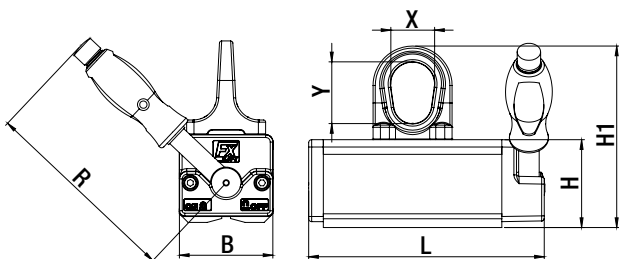

Model	Item-Nr.	Max. Load capacity (kg)		Max. Load capacity from (mm)	Dimensions (mm)						Weight (kg)
		flat	round		L	B	H	H1	R	X/Y	
FX-150	1101 0150	150 kg	Ø50-200 mm 75 kg	8	161	64	60	124	136	30/42	3,6
FX-300	1101 0300	300 kg	Ø50-300 mm 150 kg	15	205	87	78	158	190	42/53	8,4
FX-600	1101 0600	600 kg	Ø80-400 mm 300 kg	20	288	112	94	189	228	51/62	19
FX-1000	1101 1000	1000 kg	Ø100-450 mm 500 kg	25	361	152	120	240	261	60/76	42
FX-2000	1101 2000	2000 kg	Ø120-600 mm 1000 kg	50	472	228	169	313	409	68/89	115
FX-3000	1101 3000	3000 kg	Ø250-600 mm 1500 kg	50	648	228	169	313	534	68/89	166

Safety factor 3,5/Test method EN 13155  
max. Operation temperature 80°C • Load charts and Safety from Page 59



## FX-R Permanent Lifting Magnet especially suitable for Round Material

FX-R is the lifting magnet series for round material handling. The deep flat angle prism ensures safe positioning on the load and directs the magnetic field deep into the material. The magnet system can be switched good in the entire Diameter. It does not snap back, shearing off the load by turning is prevented by a cross prism.

Sheet, even with low material thickness, is no problem for the FX-R. On hot workpieces, the deep prism protects the magnetic core from overheating.

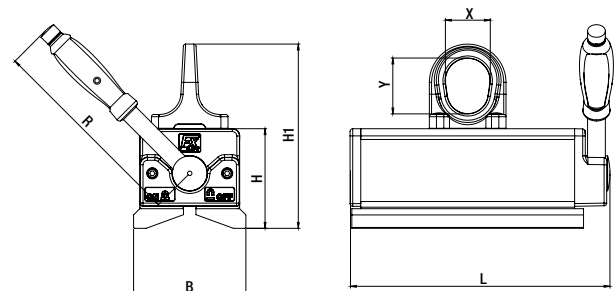
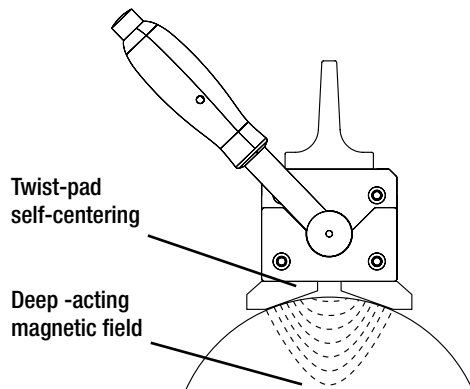

Model	Item-Nr.	Max. Load capacity (kg)		Max. Load capacity from (mm)	Dimensions (mm)						Weight (kg)
		flat	round		L	B	H	H1	R	X/Y	
FX-R100	1101 0101	100	Ø 25-150 mm 100 kg	8	161	70	68	132	136	30/42	4
FX-R225	1101 0221	225	Ø 50-205 mm 225 kg	10	205	98	90	170	190	42/53	9,5
FX-R450	1101 0451	450	Ø 50-270 mm 450 kg	20	288	126	112	207	228	51/62	22
FX-R750	1101 0751	750	Ø 70-370 mm 750 kg	20	361	170	142	262	261	60/76	49
FX-R1200	1101 1201	1200	Ø 120-560 mm 1200 kg	40	472	248	190	334	409	68/89	127
FX-R1800	1101 1801	1800	Ø 120-560 mm 1800 kg	40	648	248	190	334	534	68/89	182

Safety factor 3,5/Test method EN 13155  
max. Operation temperature 80°C • Load charts and Safety from Page 59

## FX-P Permanent Lifting magnets especially for thin sheets and pipes

FX-P is the lifting magnet series for professional lifting and moving of thinner sheets, tubes and bars. The special Magnet-Configuration in conjunction with the prismatic pole of the FX-P ensures maximum flux density even on thin material thickness.

The FX-P can be positioned well on round tube and gently pressed.

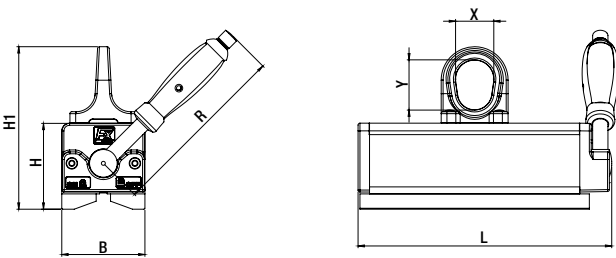

For thin sheet

Model	Max. Load capacity at sheets and 4-edge pipes							Pipes and rods	
	3mm	4mm	6mm	8mm	10mm	15mm	LxB max.	Ø kg	L Ømm
FX-P170	50	80	120	170	170	170	2000x1250	150	30-105
FX-P330	70	100	160	300	330	330	2500x1250	300	40-160
FX-P650	100	160	200	450	530	650	3000x1500	550	60-210

Model	Item-Nr.	Max. Load capacity (kg)		Max. Load capacity from (mm)	Dimensions (mm)						Weight (kg)
		flat	round		L	B	H	H1	R	X/Y	
FX-P170	1101 0172	170 kg	Ø 30-105 mm 150 kg	8	195	64	70	134	136	30/42	5,1
FX-P330	1101 0332	330 kg	Ø 40-160 mm 300 kg	10	265	87	90	170	190	42/53	12,4
FX-P650	1101 0652	650 kg	Ø 60-210 mm 550 kg	20	352	112	108	203	228	51/62	26

Safety factor 3,5/Test method EN 13155  
max. Operation temperature 80°C • Load charts and Safety from Page 59

## FX-V Permanent Lifting magnets with 90° Prism for beams, Profiles and hot parts

FX-V Lifting magnets are specifically tailored to the areas of application in the steel, shipbuilding and container construction. They have a long, narrow design for receiving carriers and Profiles - also on the inner web of the beam - and reach its maximum holding power so that even thin sheets can be lifted safely even at comparatively low material thickness. Thanks to the 90° prism, angle profiles can securely be received or components are turned. When lifting glad internal cuts, the deep prism protects the built-in magnets from heat.

The FX-V, like all FX models, has a completely nickel-plated magnetic body and provides very good test results, even in rough surfaces. Also the FX-V has a stable smooth one-hand switch.



150°C/100%

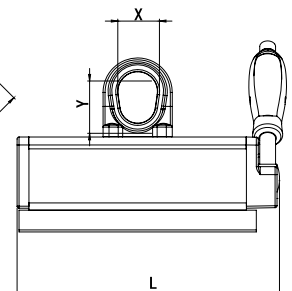
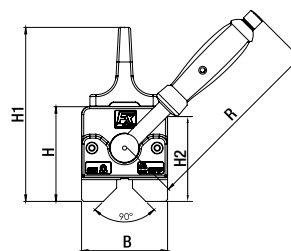

FX-V	H2 (mm)	IPE	HEB
FX-V 200	65	from IPE 80	from HEB 100
FX-V 400	87	from IPE 100	from HEB 120
FX-V 800	106	from IPE 140	from HEB 160

Model	Item-Nr.	Max. Load capacity (kg)			Max. Load capacity from (mm)	Dimensions (mm)						Weight (kg)
		flat	round	90°		L	B	H	H1	R	X/Y	
FX-V200	1101 0203	200 kg	∅ 20-50 mm 100 kg	120 kg	10	195	64	77	141	134	30/42	5,5
FX-V400	1101 0403	400 kg	∅ 25-60 mm 200 kg	250 kg	15	265	87	96	176	188	42/53	13
FX-V800	1101 0803	800 kg	∅ 35-75 mm 300 kg	400 kg	20	352	112	115	210	228	51/62	28

Safety factor 3,5/Test method EN 13155  
max. Operation temperature 150°C • Load charts and Safety from Page 59

## FX-HV Horizontal-Vertical Systems

The FX-HV Horizontal-Vertical System will meet with its diverse setting almost any need. Overall height and focus can be adjusted by plug pins. Likewise, the device also can be used for up to 20% of its rated load without engaging under pads. The support pins are positioned in a way so that standing blanks can be struck, which, for example, is often required on the saw.

Likewise lying discs and sheets can be placed. For horizontal transport, the system has a lifting eye on the back. The steel structure is completely coated, and the stable FX Lifting magnet ensures maximum safety. Special dimensions are available on request.

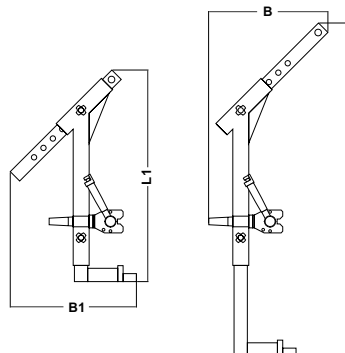

Model	Item-Nr.	Slices-Ø (mm)	Flat material Dimensions (mm)	Max. Load capacity with stop (kg)	Max. Load capacity without stop (kg)	Dimensions (mm)				Weight (kg)
						L	B	L1	B1	
FX-HV 150	1103 0152	150 - 420	1000 x 420	150	30	680	104	680	220	18
FX-HV 200	1103 0202	250 - 750	2000 x 750	200	40	1000	400	715	390	24
FX-HV 400	1103 0402	400 - 1000	2000 x 1000	400	80	1250	450	795	475	31
FX-HV 800	1103 0802	500 - 1200	2500 x 1250	800	160	1500	500	1040	520	70
FX-HV 2000	1103 2002	500 - 1200	2500 x 1250	2000	400	1800	600	1200	650	243
FX-HV 3000	1103 3002	500 - 1200	2500 x 1250	3000	600	1800	600	1200	650	294

max. Operation temperature 80° • Weight incl. Magnet

## Towing Eye for FX Lifting Magnets

Special option "towing-eyelet" for FX lifting magnets. For vertical transport of lighter parts FX lifting magnets can come with an extra towing-eyelet.



Model	Item-Nr.	Max. towing capacity (kg)
FX-150 Towing Eyelet	8 1101 0001	30
FX-300 Towing Eyelet	8 1101 0002	60
FX-600 Towing Eyelet	8 1101 0003	120
FX-1000 Towing Eyelet	8 1101 0004	200



FX-HV 3000 for up to 3.000kg

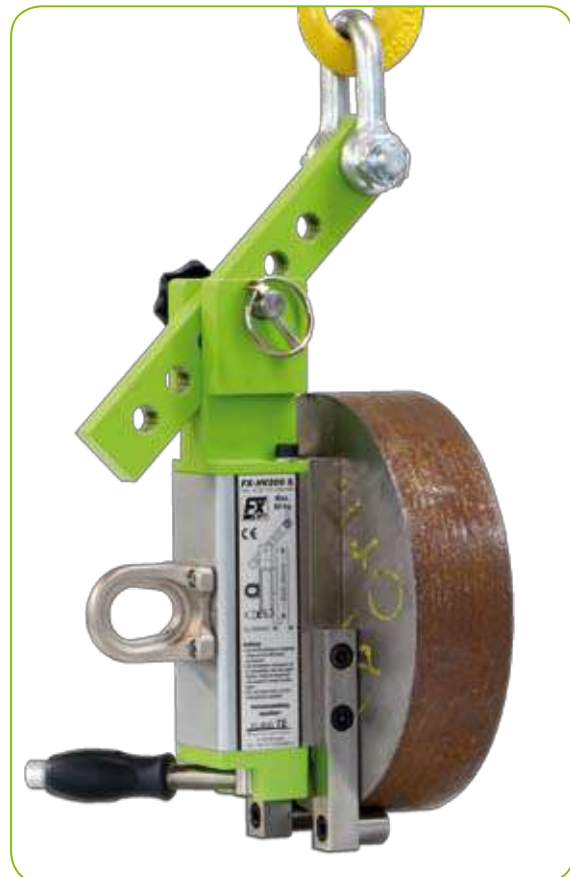

FX-HV 200-S Special Version

## FX-LT Permanent Magnetic Truss

FX-LT magnet trusses adapted to the needs of metal fabricators, laser and cutting torches. Two FX-V Lifting magnets and a slight distance truss with 2-strain chain allows the loading and unloading of machines with sheets, or the horizontal Pick up of workpieces with center cutout. With a few simple steps the magnets can be removed from the crossbar to lift blanks and small plates with only one magnet.

Delivery includes:

- 2 Lifting magnets
- 2-strain chain with hooks and eyelets
- Distance truss with suspension elements



Quick detachable for single use

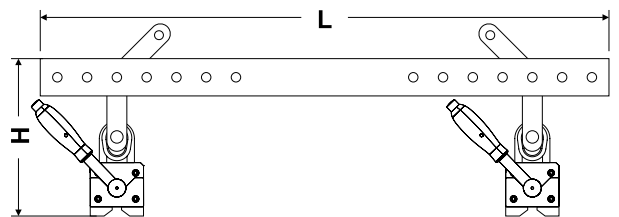

Model	Item-Nr.	incl. 2x FX	Max. Load (kg)	capacity from (mm)	Max. Workpiece Dimensions (mm)	Dimensions (mm)		Weight (kg)
						L	H	
FX-LT600	1104 0600	FX-P330	600	10	4000 x 1500	1600	270	44
FX-LT700	1104 0700	FX-V400	700	15	5000 x 1500	1600	270	44
FX-LT1000	1104 1000	FX-600	1000	20	5000 x 1500	1600	291	58
FX-LT1400	1104 1400	FX-V800	1400	20	5000 x 2000	1600	360	86
FX-LT3200	1104 3200	FX-2000	3200	50	5000 x 2500	2000	480	305
FX-LT4800	1104 4800	FX-3000	4800	50	5000 x 2500	2000	600	410

## FX-LT Permanent Magnetic Truss



### FX-LT600

Material thickness (mm)	Max. Dimensions (mm)		Max. Load (kg)
	L (max)	B (max)	
≥ 3	2000	1000	120
≥ 4	3000	1500	160
≥ 6	3500	1500	250
≥ 8	4000	1500	480
≥ 10	4000	1500	600

### FX-LT700

Material thickness (mm)	Max. Dimensions (mm)		Max. Load (kg)
	L (max)	B (max)	
≥ 4	3000	1500	180
≥ 6	3500	1500	260
≥ 8	4000	1500	490
≥ 10	4500	1500	610
≥ 15	5000	1500	700

### FX-LT1000

Material thickness (mm)	Max. Dimensions (mm)		Max. Load (kg)
	L (max)	B (max)	
≥ 4	3000	1500	180
≥ 6	3000	1500	250
≥ 8	4000	1500	300
≥ 10	4500	1500	500
≥ 15	4500	1500	820
≥ 20	5000	1500	1000

### FX-LT1400

Material thickness (mm)	Max. Dimensions (mm)		Max. Load (kg)
	L (max)	B (max)	
≥ 4	3000	1500	180
≥ 6	3000	2000	350
≥ 8	4000	2000	700
≥ 10	4500	2000	800
≥ 15	5000	2000	1130
≥ 20	5000	2000	1400

### FX-LT3200

Material thickness (mm)	Max. Dimensions (mm)		Max. Load (kg)
	L (max)	B (max)	
≥ 15	4000	2000	800
≥ 20	5000	2000	1600
≥ 25	5000	2000	1920
≥ 40	5000	2500	2560
≥ 50	5000	2500	3200

### FX-LT4800

Material thickness (mm)	Max. Dimensions (mm)		Max. Load (kg)
	L (max)	B (max)	
≥ 15	5000	2000	1200
≥ 20	5000	2000	2400
≥ 25	5000	2500	2880
≥ 40	5000	2500	3840
≥ 50	5000	2500	4800

## FX-KT Small Trusses

FX-KT Small Trusses are adapted to the needs of sheet metalworkers, laser and flame cutters. Two FX magnets and one adjustable small bar allow the transport of workpieces with a central cutout. In particular, rings and cylindrical workpieces with a central cut can be transported efficiently and effortlessly with the FX-KT.

In a few simple steps, the magnets can be removed from the crossmember to lift blanks and small plates with only one magnet.

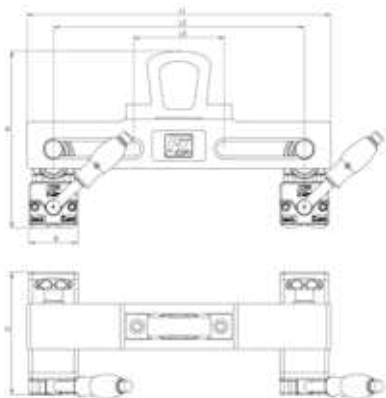

Model	Item-Nr.	Max. Load (kg)	Capacity from (mm)	Dimensions (mm)						Magnetic adjustment inner edge-inner edge (mm)	Weight (kg)
				L1	L2	L3	B	C	H		
FX-KT 240-260	1105 0240-260	240	8	400	330	120	64	161	233	58-260	15
FX-KT 240-420	1105 0240-420	240	8	560	484	120	64	161	233	58-420	15
FX-KT 240-470	1105 0240-470	240	8	607	537	120	64	161	233	58-470	20
FX-KT 240-540	1105 0240-540	240	8	680	603	120	64	161	233	58-540	22
FX-KT 480-440	1105 0480-440	480	15	620	504	150	87	205	269	65-440	26
FX-KT 480-600	1105 0480-600	480	15	800	690	150	87	205	269	65-600	30
FX-KT 480-800	1105 0480-800	480	15	1000	887	150	87	205	286	65-800	32



## PML Permanent Lifting Magnet

PML magnets convince with standard through their wide range of applications. PML reaches both with large air gaps and in thin materials and round materials good results with a compact design and low weight. The tested by "TÜV Südwest" device is characterized by great robustness and a very good price/performance ratio.

Optionally, PML is available with rear lifting eye for towing or used for profiled workpieces with special geometries with "Special-pole-pieces".



Model	Item-Nr.	Max. rec. Load capacity (kg)		Max. Load capacity from (mm)	Dimensions (mm)			tested Load capacity (kg)	Weight (kg)
		—	●		L	W	H		
PML 1	1001 0100	100	Ø50-150 mm 50 kg	12	88	62	64	350	2,6
PML 3	1001 0300	300	Ø60-300 mm 150 kg	15	158	92	88	1050	9
PML 6	1001 0600	600	Ø80-300 mm 300 kg	20	228	122	112	2100	22
PML 10	1001 1000	1000	Ø80-300 mm 500 kg	30	258	176	158	3500	48
PML 20	1001 2000	2000	Ø150-450 mm 1000 kg	45	378	215	206	7000	110

max. Operation temperature 80°C • Load charts and Safety from Page 59

## PML-R Permanent Lifting Magnet

PML - R is the lifting magnet series for round material handling. Equipped with an extra-deep, flat -angled prism, the magnetic field is led deep into the round material, thus ensuring even in poor surface finish for a secure grip. The current trend to build lifting magnets as small and light as possible is, especially in the application round material Lifting strong at the expense of safety. Of course, all the lifting magnets of round materials are checked, but just under laboratory conditions, without taking into account the risk of lateral shearing and none-centric touchdown. PML-R Lifting magnets lie down with their distinctive prism centered on cylindrical loads and begin twisting movements mechanically. The magnet system can be easily switched by the large-area contact to the material and does not beat back upon release. Especially suitable are PML-R Lifting magnets also for lifting metal sheets with thickness from 6 mm. The wide design for more rigidity to the workpiece and the tapered pole piece for maximum magnetic flux density. Another advantage of the pronounced prism when handling hot parts, because the magnet system is further away from the workpiece and air can flow through the prism aperture.

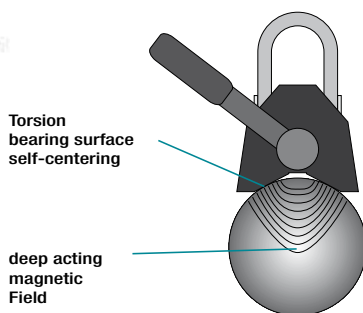

Model	Item-Nr.	—	Max. Load Capacity (kg)		Max. Load Cap. from (mm)	Dim. (mm)			Prism (mm)		Weight (kg)
			●			L	W	H	Depth	Width	
PML-R 1	1001 0101	100	Ø 40-150mm 60 kg	-	10	90	86	75	10	60	3
PML-R 3	1001 0301	300	Ø 60-200mm 200 kg	-	10	160	123	115	20	90	11
PML-R 6	1001 0601	600	Ø 60-200mm 400 kg	Ø 200-300mm 450 kg	15	230	194	145	29	142	29
PML-R 10	1001 1001	1000	Ø 80-200mm 500 kg	Ø 200-360mm 750 kg	25	270	279	205	42	225	70
PML-R 20 *	1001 2001	2000	Ø 100-200 1000 kg	Ø 200-460mm 1300 kg	40	390	371	260	56	270	190

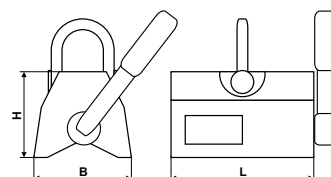

max. Operation-temperature 80° • Loadtable on Page 44!  
If the specified diameter and supporting forces of your workpieces not do justice, do not fit or the dimensions of the magnets, so you ask us, we will develop a solution for you.  
\* lacquered yellow

## PML-H Permanent Lifting Magnet

PML-H Lifting magnets hold loads permanently at high temperatures. A samarium-cobalt permanent magnet system allows operating temperatures of up to 300°C. The standard configuration with 90° prism can be fashioned on request to accommodate profiled standard parts or special diameter. Ideal for moving heated tools and dies, or heat-treated workpieces. The maximum continuous operating temperature is 250°C - in spikes up to 5 minutes at 300°C.



max. 300°C

Model	Item-Nr.	—	Max. Load Capacity (kg)		Max. Load Cap. from (mm)	Dim. (mm)			Weight (kg)	
			●	90°		L	W	H		
PML-H 3	1001 0305	300	Ø 20-55 mm	110	170	15	233	86	128	15
PML-H 6	1001 0605	600	Ø 35-95 mm	225	375	25	308	133	137	38

max. Operation-temperature 300°C

## NEO-LIFT Permanent Lifting Magnets

NEO-LIFT Permanent Lifting Magnets have proven themselves for years. They are available in 6 sizes between 150 and 2000 kg.

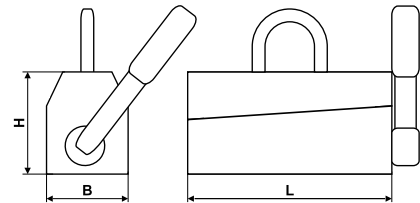

Model	Item-Nr.	Max. rec. Load-capacity (kg)			Dimensions (mm)			tested Load-capacity (kg)	Weight (kg)
		—	● with Ø in mm		L	W	H		
NEO-LIFT 150	1004 0150	150	65	50-100	93	60	120	450	3
NEO-LIFT 300	1004 0300	300	150	60-200	152	100	180	900	10
NEO-LIFT 600	1004 0600	600	300	65-270	246	120	180	1800	21
NEO-LIFT 1000	1004 1000	1000	500	100-300	316	148	216	3200	36
NEO-LIFT 1500	1004 1500	1500	750	100-360	373	165	251	4500	69
NEO-LIFT 2000	1004 2000	2000	1000	100-360	480	165	251	6000	88

max. Operation-Temperature 80°C

## MaxX Permanent Lifting Magnets

MaxX Lifting-magnets are available in 8 sizes - from 125 kg to 2000 kg. Suitability for round materials is 40% and the safety factor in 3. By chamfered pole pieces this Lifting magnets are especially suitable for materials with a very good surface.

MaxX TG lifting magnets are recommended especially for lifting of thin sheets from 8 mm thickness.



Model	Item-Nr.	Max. rec. Load-capacity (kg)			Max. Load-capacity from (mm)	Dimensions (mm)			tested Load-capacity (kg)	Weight (kg)
		—	● with Ø in mm			L	W	H		
MaxX 125	1002 0125	125	50	50-200	20	121	79	79	375	3,5
MaxX 250	1002 0250	250	100	50-300	20	189	79	79	750	6
MaxX 500	1002 0500	500	200	80-400	25	249	106	101	1500	16
MaxX 1000	1002 1000	1000	400	100-450	40	342	133	131	3000	36
MaxX 1500	1002 1500	1500	600	100-500	45	383	166	171	4500	65
MaxX 2000	1002 2000	2000	800	120-600	55	457	166	171	6000	79
MaxX-TG 150	1002 0015	150	60	50-300	8	189	79	142	450	6
MaxX-TG 300	1002 0030	300	120	80-400	10	250	106	190	900	16

max. Operation-temperature 80°C

## PML-C Permanent Lifting Magnet

PML-C Lifting magnets have a circular multi-pole clamping surface and are therefore ideally suited to lift workpieces having an annular contact surface and bearing housings, flange plates and rings. Since annular workpieces often the contact surface is reduced to the magnet, the max. Be roughly calculated carrying capacity as follows : Contact surface in  $\text{cm}^2 \times 4 = \text{max. Load in kg}$ . These notional value are still the reduction factors for alloy, hardness and temperature to be counted . Whether the required safety factor of 3 in series workpieces is achieved must be checked. In the non-magnetic center of the rake face is a M10 thread, onto which a centering disc or pin can be screwed.



Model	Item-Nr.	Max. rec. Load-capacity (kg)	Max. Load-capacity from (mm)	Dimensions (mm)		Pole	Weight (kg)
				Ø	H		
PML-C 15	1001 0157	100	12	150	57	10	10
PML-C 20	1001 0207	200	15	200	57	12	15
PML-C 25	1001 0257	250	15	250	70	16	26
PML-C 30	1001 0307	300	15	300	73	16	38

max. Operation-temperature 80°C

## PML-RP Permanent Lifting Magnets

Type PML-RP Lifting Magnets are made to lift flat or ring-shaped Loads. Steel-Workpieces with a Material thickness of 15mm and good surface can be lifted.



Especially suitable for ring shaped Sleeves



Model	Item-Nr.	Max. Load Capacity (kg)	Dimensions on Rings		Max. Load Cap. from (mm)	Dim. (mm)		Weight (kg)
			Min. Outline-Ø	Min. Inline-Ø		Ø	H	
PML-RP 300	1001 0167	300	70mm	120mm	15	160	230	23

max. Operation-temperature 80°C

## SH / MK-KS Permanent Magnetic Transporter

Permanent Magnetic transporters are used where switchable lifting magnets cannot be used because of low material thicknesses. They are suitable for thin metal sheets from 3 mm and are more cost effective than lifting magnets, but must be separated by means of a push-off train from the workpiece. Their use provides in sheet stock, on the internal or laser cutting machine, the shears or punching machine and in the steel and container-building.

**Magnet transporter types SH and MK are not compatible with the latest European standard for lifting magnets. We recommend its use only in protected areas.**



SH



MK - KS

Model	Item-Nr.	adhesive surface (mm)	lifting force (kg)	towing force (kg)	sheet thickness from (mm)	Weight (kg)
SH 25	1007 025	190 x 110	200	ca. 60	3	4
SH 60	1007 060	310 x 190	500	ca. 200	3	12
MK 250 KS	1008 250	290 x 125	250	100	4	7,2
MK 500 KS	1008 500	290 x 180	300	125	4	10,5

max. Operation-temperature 80°C / 3-times Safety for Crane-use

## SHX / MK / PML1-H / HM Hand Magnetic Transporter

Magnetic clutches are the flexible attachable handle on steel parts and sheets. They are simply placed in the desired location and released mechanically again.

**SHX and MK:**

Ideal for solid and rolled sheet metal parts, the SH with hard plastic case is the cost-effective alternative to MK with cast-aluminum housing.

**PML1-H:**

Is recommended especially for flame cuts and parts with bad surfaces



SHX 100



MK



PML1-H

Model	Item-Nr.	adhesive surface (mm)	lifting force (kg)	towing force (kg)	sheet tickness from (mm)	Weight (kg)
SHX 100	1008 100	125 x 85	100	60	2	1,9
MK 120	1008 120	140 x 84	120	70	1	1,4
MK 170	1008 170	140 x 116	170	100	2	1,8
MK 300	1008 300	160 x 180	300	180	2	3,5
PML1-H	1007 0100	88 x 62	150	-	12	3

2x Safety for maunal Lifting

## HM Handmagnets

Hand magnets are especially recommended to sheet metal parts such as laser cutting, which can be recorded poorly or have sharp edges, quickly implement by hand. The magnets are solved by lateral tilting of the workpiece.

Model	Item-Nr.	Holding area (mm)	Lifting power (kg)	Sheet thickness from (mm)	Weight (kg)
HM 1	1008 001	Ø 80	5	1	0,65
HM 2	1008 002	Ø 125	10	1	2
HM 10	1008 010	19 x 98	15	1	0,4



## Permanent Lifting Magnets in Special Versions

Permanent lifting magnets are manufactured with the most different special-pole-pieces and as load spreader for almost all geometries. We manufacture magnets for spherical surfaces, with long pole pieces, for rings and sleeves and profiles. All special Lifting magnets are constructed, tested and documented in accordance with EN 13155 and MD 2006/42 EEC.



## Electro-Permanent Lifting Magnets

Electro-permanent magnet technology is at lifting magnets for maximum security. The advantages of the reliability of permanent magnets and the user-friendliness of electro-magnets are united in a common approach. In the case of cable break or power failure, the lifted load cannot fall off. There are no batteries to maintain the activated / deactivated by pressing a button or radio, and the pole-reversal ensures safe release of the magnets from the workpiece. For different requirements, we offer the right solutions.

### Page 26 - 37



FXE electro-permanent lifting magnets are equipped with onboard control technology for direct connection to mains voltage - the fast, user-friendly plug and play solution for loads up to 7,2t

### Page 28 - 29



FXE-L in a long, narrow design for the installation of support profiles, bars, tubes and bars reach their maximum holding force already from 15mm material thickness

### Page 34 - 35



FXE-T Trusses for the handling of larger Formats. The unit is controlled directly on the device or optionally via a remote control

### Page 38 - 40



FXE-M electro-permanent lifting magnet modules are made in monoblock technology and extremely stable.

### Page 41



The MCF control units are available as single boards and as a complete cabinet solution. MCF are operated in conjunction with FXE-M modules

### Page 46



The SML Lifting Magnet for Heavy Lifting. Version for lifting metal sheets and steel parts with a small air gap. Ideal for feeding of cutting machines.

### Page 49



The TM 4 telescopic Truss, with direct flange mounted controls and wireless remote control; Perfect for handling thin sheets from 5 mm to 12 m length.

### Page 50



The EPM MHN Lifting Magnet is particularly suitable for the very fast moving of loads up to 150kg



Within the described application concepts, FXE has 4 different magnetic versions, defined by different Pole structure. It is important to choose the appropriate terminal type, depending on requirements.

## Pole Structure 50

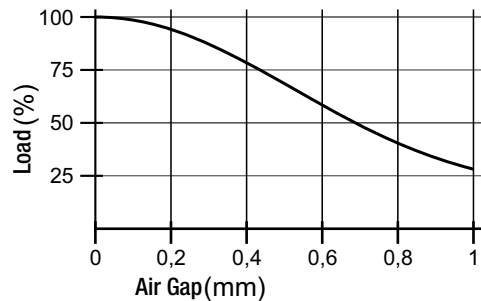
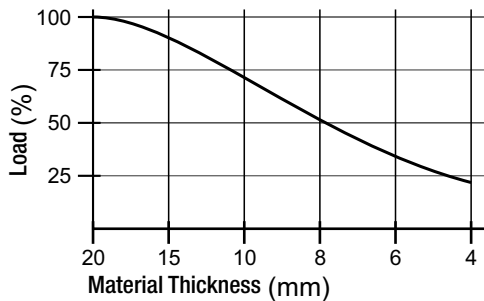

Pole structure 50 is designed for lifting sheets from 4 mm and Steel parts with a flat or processed surface. The nominal values of the FXE Lifting magnets with pole structure type 50 are achieved up to an Air gap of 0.3 mm. With air gap 0, the pole structure 50 reaches a holding force of 3.8 kN.

## Pole Structure 50+

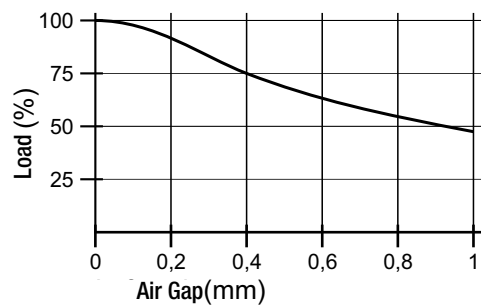
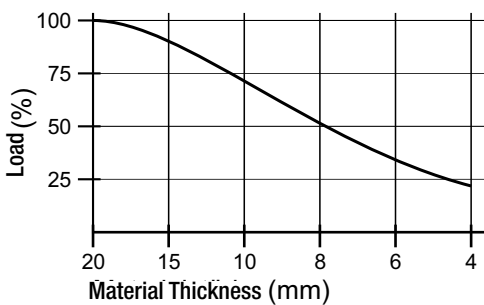

Pole structure 50+ has a reinforced Magnetic system with the same Pole size as the pole structure 50. This means, in poor Surfaces improved holding forces can be achieved, specifically even when pole extensions are needed the pole structure 50+ comes to use. With air gap 0, the pole structure 50+ reaches a holding force of 3.8 kN.

## Pole Structure 80

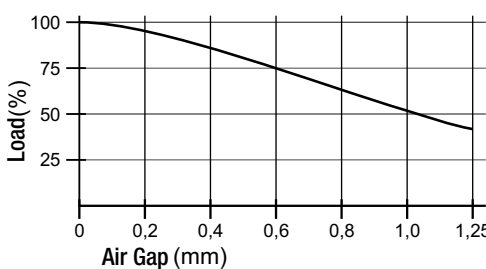
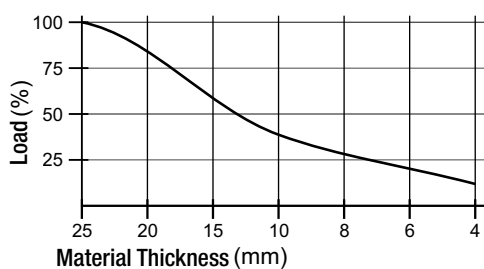

Pole structure 80 is designed for lifting sheets from 8mm and solid steel parts and internal sections with a medium air gap. The nominal values of the FXE Lifting magnets with pole structure 80 are achieved up to an air gap of 0.4mm. With air gap 0, the pole structure 80 reaches a holding force of 9 kN.

## Pole Structure 100

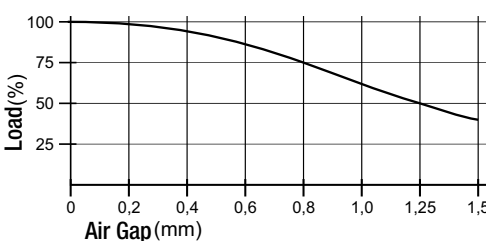
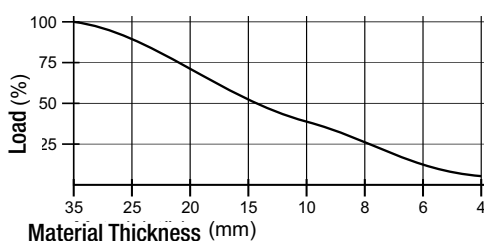

Pole structure 100 is designed for lifting of heavy plates from 12mm and massive steel, form and Forgings with larger Air gap. The nominal values of the FXE Lifting magnets with pole structure 100 are achieved up to an air gap of 0.6mm. With air gap 0, the pole structure 100 reaches a holding force of 14.5 kN.

## FXE Electro-Permanent Lifting Magnets

FXE Lifting magnets are the professional solution for the frequent turning of workpieces.

They are very robustly built and designed for continuous use. The electrical control allows the operator to turn the unit without any physical effort, even on hard to reach areas. The permanent magnet system can be activated via Pushbutton in 0.8 seconds, and when you turn off the workpiece is released safely. The connection is made easy to mains voltage. Thus, the device is ready for use with very low installation effort. If the power fails, the load is held by the permanent magnet field. For this, no prone- and maintenance-intensive back-up batteries are necessary.

A quick change of crane installations with conventional mains-powered electromagnet is possible.

FXE Lifting magnets comply with the latest standards and offer maximum safety and ease of use. With our standard sizes up to 7200 kg, we have the right equipment for almost any application.

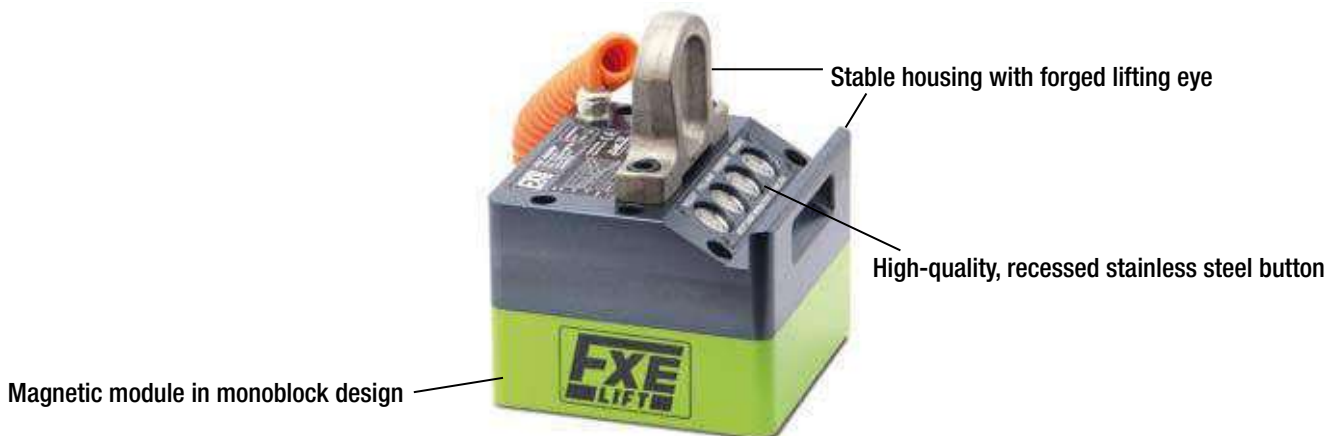

## FXE-300/50 • FXE-500/50 Electro-Permanent Lifting Magnets

Equipped with pole structure 50 and a maximum load capacity of 300/500 kg which is achieved at thicknesses from 15mm, and for small magnetically active areas, we recommend this easily to be guided and to use devices for lifting of serial parts, blanks and small castings and forgings.

### FXE-300/50

Max. Load capacity at sheets and 4-edge pipes

Material-/ Wall thickness	max. Load	Max. Dimensions	
		L (max.)	W (max.)
ab 4 mm	70 kg	1800	1500
ab 6 mm	140 kg	2000	1500
ab 8 mm	200 kg	2000	1500
ab 10 mm	280 kg	2000	1500
ab 15 mm	300 kg	2000	1500

### FXE-500/50

Max. Load capacity at sheets and 4-edge pipes

Material-/ Wall thickness	max. Load	Max. Dimensions	
		L (max.)	W (max.)
ab 4 mm	100 kg	1800	1500
ab 6 mm	200 kg	2000	1500
ab 8 mm	300 kg	2000	1500
ab 10 mm	400 kg	2000	1500
ab 15 mm	500 kg	2000	1500



Model	Item-Nr.	Max. Load capacity (kg)	Dimension (mm)			Number Poles °N	Pole structure	Breakaway (kN)	clamping surface (mm)	Weight (kg)
			L	W	H					
FXE-300/50	1060 0301	300	164	164	420	4	50	14	116x116	23
FXE-500/50	1060 0501	500	234	164	420	6	50	22	180x116	31

## FXE-750/50 • FXE-1100/50 • FXE-1600/50 Electro-Permanent Lifting Magnets

Equipped with pole structure 50 and a maximum load capacity of 750/1100/1600 kg which is achieved at thicknesses from 15mm, and for small magnetically active areas, we recommend this easily to be guided and to use devices for lifting plates, laser and Internal parts, tools and blanks.



### FXE-750/50

#### Max. Load capacity at sheets and 4-edge pipes

Material-/ Wall thickness	max. Load	Max. Dimensions	
		L (max.)	W (max.)
ab 4 mm	150 kg	1800	1500
ab 6 mm	250 kg	2000	1500
ab 8 mm	400 kg	2000	1500
ab 10 mm	600 kg	2000	1500
ab 15 mm	750 kg	3000	1500

### FXE-1100/50

#### Max. Load capacity at sheets and 4-edge pipes

Material-/ Wall thickness	max. Load	Max. Dimensions	
		L (max.)	W (max.)
ab 4 mm	200 kg	2000	1500
ab 6 mm	370 kg	3000	1500
ab 8 mm	600 kg	3000	1500
ab 10 mm	900 kg	3000	1500
ab 15 mm	1100 kg	3000	1500

### FXE-1600/50

#### Max. Load capacity at sheets and 4-edge pipes

Material-/ Wall thickness	max. Load	Max. Dimensions	
		L (max.)	W (max.)
ab 4 mm	300 kg	3000	1500
ab 6 mm	500 kg	3000	1500
ab 8 mm	800 kg	3000	1500
ab 10 mm	1400 kg	3000	1500
ab 15 mm	1600 kg	3000	2000

Model	Item-Nr.	Max. Load capacity (kg)	Dimension (mm)			Number Poles °N	Pole structure	Breakaway (kN)	clamping surface (mm)	Weight (kg)
			L	W	H					
FXE-750/50	1060 0701	750	298	164	250	8	50	30	244x116	27
FXE-1100/50	1060 1101	1100	420	164	270	12	50	40	372x116	39
FXE-1600/50	1060 1601	1600	620	164	270	18	50	60	564x116	56

## FXE-L Electro-Permanent Lifting Magnets

Equipped with pole structure 50+ in long narrow design and a maximum working load of 400/600/1000 kg, which is achieved at thicknesses from 15mm, and for small magnetically active areas, we recommend this easily to be guided and to use devices for lifting of strips, bars, pipes, beams and rods. Also, using of pole extensions which facilitate it, to position the magnets on long narrow loads.



## FXE-L400/50+ Electro-Permanent Lifting Magnets



### FXE-L400/50+

Max. Load capacity at sheets and 4-edge pipes

Material-/ Wall thickness	max. Load	Max. Dimensions	
		L (max.)	W (max.)
ab 4 mm	70 kg	1800	1000
ab 6 mm	140 kg	2000	1000
ab 8 mm	200 kg	2000	1000
ab 10 mm	250 kg	2500	1000
ab 15 mm	400 kg	3000	1000

Model	Item-Nr.	Max. Load capacity (kg)	Dimension (mm)			Number Poles °N	Pole structure	Breakaway (kN)	clamping surface (mm)	Weight (kg)
			L	W	H					
FXE-L400/50+	1060 0411	400	294	95	450	4	50+	14	244x52	23

## FXE-L600/50+ Electro-Permanent Lifting Magnets

### FXE-L600/50+

Max. Load capacity at sheets and 4-edge pipes

Material-/ Wall thickness	max. Load	Max. Dimensions	
		L (max.)	W (max.)
ab 4 mm	100 kg	2000	1000
ab 6 mm	200 kg	2500	1000
ab 8 mm	300 kg	2500	1000
ab 10 mm	350 kg	3000	1000
ab 15 mm	600 kg	4000	1000



Model	Item-Nr.	Max. Load capacity (kg)	Dimension (mm)			Number Poles °N	Pole structure	Breakaway (kN)	clamping surface (mm)	Weight (kg)
			L	W	H					
FXE-L600/50+	1060 0611	600	420	95	450	6	50+	22	372x52	31

## FXE-L1000/50+ Electro-Permanent Lifting Magnets

### FXE-L1000/50+

Max. Load capacity at sheets and 4-edge pipes

Material-/ Wall thickness	max. Load	Max. Dimensions	
		L (max.)	W (max.)
ab 4 mm	150 kg	2500	1500
ab 6 mm	300 kg	3000	1500
ab 8 mm	400 kg	3000	1500
ab 10 mm	500 kg	4000	1500
ab 15 mm	1000 kg	5000	1500



Model	Item-Nr.	Max. Load capacity (kg)	Dimension (mm)			Number Poles °N	Pole structure	Breakaway (kN)	clamping surface (mm)	Weight (kg)
			L	W	H					
FXE-L1000/50+	1060 1011	1000	680	95	450	10	50+	38	628x52	44

## FXE-1000/80 Electro-Permanent Lifting Magnets

Equipped with pole structure 80 and a maximum load capacity of 1000 kg which is achieved at thicknesses from 25mm, and for small magnetically active areas, we recommend this easily to be guided and to use devices for lifting of heavy plates, plasma and flame-cut parts, Tools and blanks.



### FXE-1000/80

Max. Load capacity at sheets and 4-edge pipes

Material-/ Wall thickness	max. Load	Max. Dimensions	
		L (max.)	W (max.)
ab 8 mm	200 kg	2000	1500
ab 10 mm	300 kg	2000	1500
ab 15 mm	600 kg	2000	1500
ab 25 mm	1000 kg	2000	1500

Model	Item-Nr.	Max. Load capacity (kg)	Dimension (mm)			Number Poles °N	Pole structure	Breakaway (kN)	clamping surface (mm)	Weight (kg)
			L	W	H					
FXE-1000/80	1060 1002	1000	228	228	295	4	80	36	172x172	39

## FXE-2500/80 Electro-Permanent Lifting Magnets

Equipped with pole structure 80 and a maximum load capacity of 2500 kg which is achieved at thicknesses from 25mm, and for small magnetically active areas, we recommend this easily to be guided and to use devices for lifting of heavy plates, plasma and flame-cut parts, Tools and blanks.



### FXE-2500/80

Max. Load capacity at sheets and 4-edge pipes

Material-/ Wall thickness	max. Load	Max. Dimensions	
		L (max.)	W (max.)
ab 8 mm	500 kg	2000	1500
ab 10 mm	750 kg	3000	1500
ab 15 mm	1500 kg	3000	1500
ab 25 mm	2500 kg	3000	2000

Model	Item-Nr.	Max. Load capacity (kg)	Dimension (mm)			Number Poles °N	Pole structure	Breakaway (kN)	clamping surface (mm)	Weight (kg)
			L	W	H					
FXE-2500/80	1060 2502	2500	506	228	295	10	80	90	448x172	77

## FXE-4000/80 Electro-Permanent Lifting Magnets

Equipped with pole structure 80 and a maximum load capacity of 4000 kg which is achieved at thicknesses from 25mm, and for small magnetically active areas, we recommend this easily to be guided and to use devices for lifting of heavy plates, plasma and flame-cut parts, Tools and blanks. The outwardly offset control and operating unit makes it easier to clear firing- and machine tables.



Optionally available with 2 control panels



### FXE-4000/80

Max. Load capacity at sheets and 4-edge pipes

Material-/ Wall thickness	Max. Load	Max. Dimensions	
		L (max.)	W (max.)
ab 8 mm	800 kg	3000	1500
ab 10 mm	1200 kg	3000	1500
ab 15 mm	2400 kg	3000	1500
ab 25 mm	4000 kg	4000	1500

Model	Item-Nr.	Max. Load capacity (kg)	Dimension (mm)			Number Poles °N	Pole structure	Breakaway (kN)	clamping surface (mm)	Weight (kg)
			L	W	H					
FXE-4000/80	1060 4002	4000	783	228	295	16	80	144	724x172	132

## FXE-1600/100 Electro-Permanent Lifting Magnets

Equipped with pole structure 100 and a maximum load capacity of 1600/2400 kg which is achieved at thicknesses from 35mm, and for small magnetically active areas, we recommend this easily to be guided and to use devices for lifting forgings, heavy plates, Plasma and internal parts, tools, ingots...



### FXE-1600/100

Max. Load capacity at sheets and 4-edge pipes

Material-/ Wall thickness	max. Load	Max. Dimensions	
		L (max.)	W (max.)
ab 10 mm	400 kg	2000	1500
ab 20 mm	1000 kg	2000	1500
ab 35 mm	1600 kg	3000	1500

### FXE-2400/100

Max. Load capacity at sheets and 4-edge pipes

Material-/ Wall thickness	max. Load	Max. Dimensions	
		L (max.)	W (max.)
ab 10 mm	600 kg	2000	1500
ab 20 mm	1500 kg	3000	1500
ab 35 mm	2400 kg	3000	1500

Model	Item-Nr.	Max. Load capacity (kg)	Dimension (mm)			Number Poles °N	Pole structure	Breakaway (kN)	clamping surface (mm)	Weight (kg)
			L	W	H					
FXE-1600/100	1060 1603	1600	296	296	345	4	100	58	222x222	82
FXE-2400/100	1060 2403	2400	415	296	335	6	100	87	342x222	118



## FXE-3200/100 Electro-Permanent Lifting Magnets

Equipped with pole structure 100 and a maximum load capacity of 3200 kg which is achieved at thicknesses from 35mm, and for small magnetically active areas, we recommend this easily to be guided and to use devices for lifting forgings, heavy plates, Plasma and internal parts, tools, ingots...



### FXE-3200/100

Max. Load capacity at sheets and 4-edge pipes

Material-/ Wall thickness	max. Load	Max. Dimensions	
		L (max.)	W (max.)
ab 10 mm	800 kg	3000	1500
ab 20 mm	2200 kg	3000	1500
ab 35 mm	3200 kg	4000	1500

Model	Item-Nr.	Max. Load capacity (kg)	Dimension (mm)			Number Poles °N	Pole structure	Breakaway (kN)	clamping surface (mm)	Weight (kg)
			L	W	H					
FXE-3200/100	1060 3203	3200	536	296	335	8	100	112	462x222	154

## FXE-4800/100 • FXE-7200/100 Electro-Permanent Lifting Magnets

Equipped with pole structure 100 and a maximum load capacity of 4800/7200 kg which is achieved at thicknesses from 35mm, and for small magnetically active areas, we recommend this easily to be guided and to use devices for lifting forgings, heavy plates, Plasma and internal parts, tools, ingots...

### FXE-4800/100

Max. Load capacity at sheets and 4-edge pipes

Material-/ Wall thickness	max. Load	Max. Dimensions	
		L (max.)	W (max.)
ab 10 mm	1200 kg	3000	1500
ab 20 mm	3000 kg	4000	2000
ab 35 mm	4800 kg	4000	2000

### FXE-7200/100

Max. Load capacity at sheets and 4-edge pipes

Material-/ Wall thickness	max. Load	Max. Dimensions	
		L (max.)	W (max.)
ab 10 mm	1800 kg	3000	1500
ab 20 mm	3300 kg	4000	2000
ab 35 mm	7200 kg	4000	2500



Model	Item-Nr.	Max. Load capacity (kg)	Dimension (mm)			Number Poles °N	Pole structure	Breakaway (kN)	clamping surface (mm)	Weight (kg)
			L	W	H					
FXE-4800/100	1060 4803	4800	778	296	400	12	100	168	702x222	202
FXE-7200/100	1060 7203	7200	778	415	400	18	100	252	702x342	298

## FXE-T2500/50 • FXE-T4000/80 Magnetic Truss

FXE T 2500/50 and 4000/80 Electro-permanent Lifting magnet trusses in a compact design with on-board control technology are designed for the frequent transfer of larger formats. They can, like the FXE Lifting magnets, be operated directly on mains voltage and are thus installed quickly and ready for use. The unit is controlled directly on the device or optionally via a remote control.



Radio/IR-Remote Control optionally!



FXE-T 4000/80

### FXE-T2500/50

#### Max. Load capacity at sheets

Material/ Wall thickness	Max. Dimensions		
	max. Load	L (max.)	W (max.)
ab 4 mm	500 kg	3000	1500
ab 6 mm	750 kg	3000	1500
ab 8 mm	1250 kg	4000	2000
ab 10 mm	1750 kg	4000	2000
ab 15 mm	2550 kg	4000	2500

### FXE-T4000/80

#### Max. Load capacity at sheets

Material/ Wall thickness	Max. Dimensions		
	max. Load	L (max.)	W (max.)
ab 4 mm	350 kg	4000	1500
ab 6 mm	700 kg	4000	1500
ab 8 mm	1000 kg	4000	2000
ab 10 mm	1250 kg	4000	2000
ab 15 mm	2500 kg	5000	2500
ab 25 mm	4000 kg	5000	2500

Model	Item-Nr.	Max. Load capacity (kg)	Dimension (mm)			Number Poles °N	Pole structure	Breakaway (kN)	Weight (kg)
			L	W	H				
FXE-T2500/50	1068 2501	2500	1000	630	380	2x18	50	96	138
FXE-T4000/80	1068 4002	4000	1200	500	380	2x10	80	170	175

## FXE-T6400/80 Magnetic Truss

The FXE T 6400/80 Electro-permanent Lifting magnet truss is a full-featured standard equipment with all options. The truss with 6400 kg Max. Carrying capacity is held with sliding magnetic modules and can thus move sheet formats of min. 1200 mm length max. 6000 mm length safely.

Delivery includes:

- Radio remote control with Pick Up function to lift individual plates from 6mm
- Weld-on hooks on the sides for each 4t max.
- 2-strain chains
- Lifting-eyelet sensor, demagnetizing only possible when load-free
- 360° LED signal tower
- Stainless steel guide handles
- Primary connection cable ready for 400V/25A fuse/CEE 32A plug



### FXE-T6400/80

#### Max. Load capacity at sheets

Material/ Wall thickness	max. Load	Max. Dimensions	
		L (max.)	W (max.)
ab 4 mm	500 kg	4000	2000
ab 6 mm	1000 kg	6000	2500
ab 8 mm	1400 kg	6000	2500
ab 10 mm	2000 kg	6000	3000
ab 15 mm	4000 kg	6000	3000
ab 25 mm	6400 kg	6000	3000

Model	Item-Nr.	Max. Load capacity (kg)	Dimension (mm)			Number Poles °N	Pole structure	Breakaway (kN)	Weight (kg)
			L	W	H				
FXE-T6400/80	1068 6402	6400	3150	780	1900	2x16	80	272	520

## FXE-R Electro-Permanent Lifting Magnets

FXE-R Lifting magnets can pick up round material or both rotary and flat material. We manufacture from our FXE-based models with pole shoes, which can raise the customized diameter bandwidths individually or in layers.



Model	Item-Nr.	Max. Load Cap. (kg)		Dimension (mm)			Number Poles °N	Pole structure	Breakaway (kN)	Weight (kg)
		flat	round	L	W	H				
FXE-R 2400/100	1062 2403	2400	Ø120-420 mm 1200 kg	536	296	370	8	100	80	158

Consistent sample model, many other Versions available

## FXE-Z Electro-Permanent Lifting Magnets

FXE-Z lifting magnets with additional demagnetizing we produce from our FXE- basic models with adjusted Magnet System. With FXE-Z, workpieces that keep disturbing residual magnetism after transportation, such as alloyed mold plates or hardened driving parts and bearing parts, can be moved and demagnetized after transport.

Please note that the design compared to the magnetic power is clearly higher than in standard FXE models. The Quality of demagnetization depends on the workpiece, not every request can be reached.



Model	Item-Nr.	Max. Load capacity (kg)	Dimension (mm)			Number Poles °N	Pole structure	Breakaway (kN)	Weight (kg)
			L	W	H				
FXE-Z 500/80	1064 0512	500	430	230	295	8	80	18	60

Consistent sample model, many other Versions available

## The FXE electro permanent lifting magnet series can be customized by adding intelligent accessories to further increase productivity and safety.

### Spiral cable

Included in the standard package are 2m heavy rubber hose line and a CEE three-phase connector (16/32A). High-quality spiral cable make specially sense with small fast hoists up to 4m hook height.



### Eyelet-Sensor

The Eyelet-Sensor checks whether the lifting eye on the magnet is on load, and only allows demagnetization in no-load. This provides more security, but prevents the option, for example slugs on a discard container.



### Pick Up function

The „Pick Up,, option is for taking a thin sheet of a stack. Similarly, the „Pick Up,, option makes visible the safety factor. A floating in reduced load mode Pick Up load can be magnetized - then it can be considered by a standardized safety factor.



### Special pole shoes

For receiving hot parts we recommend using Heat-protection pole shoes, Form-pole-shoes for round materials, profiles or bulky castings we produce custom made pole shoes, so that the receiving surface matches the load.



Remote control in radio or infrared technology. For remote control you can use both Radio and IR technology. IR has price advantages, but requires a direct line of sight to the receiver and has a short range of only about 5m. Radio has a range of at least 30m, therefore but also recommended the use of a radio FB addition the option „Eyelet-Sensor,, .



### Guide handle

Especially when removing small work-pieces from the flame cutting table the magnet can be positioned not only to the crane, but must be done manually. Here the „guiding hand“ option is recommended. With integrated circuit that allows the operator to easily clear the internal table from the side.

Article	Item-Nr.	Weight (kg)
Spiral cable 3x2.5 1-5m	1013 5325	2
Spiral cable 3x2.5 0,5-2m	1013 5326	1
Spiral cable 4x4mm <sup>2</sup> 1-5m (use from FXE3200)	1013 626	3
4x6 mm <sup>2</sup> Spring cable reel 10m	1016 0001	34
5x2,5mm <sup>2</sup> Spring cable reel 10m	1016 0002	20

Article	Item-Nr.	Weight (kg)
Eyelet-Sensor FXE	8 1060 0001	1
Eyelet-Sensor Trusses	8 1060 0002	2
Pick Up Option	8 1060 0003	-
Special pole shoes	auf Anfrage	-
Radio remote control	1013 6002	-
IR remote control	1013 6001	-
Guide handle FXE	8 1060 0005	15

## FXE-M Electro-Permanent Lifting Magnet Systems

FXE-M electro-permanent lifting magnet modules can be put together in conjunction with MCF magnetic control units to modular lifting systems.

Thus, a single FXE-M module with a MCF-1 channel control, for example, be used on the crane of a gas cutting machine, or 4 FXE-M modules, which are jointly or individually driven by an MCF-4 channel controller, can operate in a fully automatic profile steel plant, In use in cranes, manipulators, conveyors and robots to FXE-M modules have proven thousands of times for years.

FXE-M modules are made in monoblock technology and extremely stable. You can choose between 4 different terminal types to use the matching magnet module depending on the load, dimensions and surface, As with other products in the series FXE.

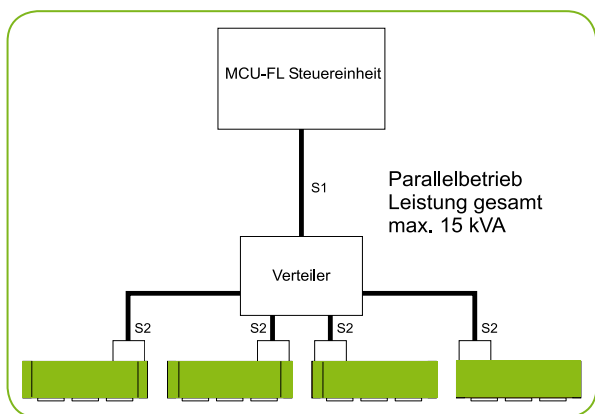

Connecting several FXE-M modules

	Length cable max. S1 + S2 max. (m)	
	3 x 2,5 <sup>2</sup>	3 x 4 <sup>2</sup>
up to 8 kVA	20	30
up to 16 kVA	6	15

Model	Item-Nr.	Max. Load capacity		Dimensions (mm)			Number Poles °N	Pole structure	Breakaway (kN)	Weight (kg)
		(kg)	from (mm)	L	W	H				
FXE-M 150/50	1061 0101	150	15	164	95	64	2	50	7	6
FXE-M 300/50	1061 0301	300	15	164	164	64	4	50	14	12
FXE-M 400/50	1061 0401	400	15	294	95	64	4	50	14	12
FXE-M 500/50	1061 0501	500	15	234	164	64	6	50	21	16
FXE-M 600/50	1061 0601	600	15	420	95	64	6	50	21	16
FXE-M 750/50	1061 0701	750	15	298	164	64	8	50	30	20
FXE-M 1000/50	1061 1001	1000	15	680	95	64	10	50	36	28
FXE-M 1100/50	1061 1101	1100	15	420	164	64	12	50	40	32
FXE-M 1600/50	1061 1601	1600	15	620	164	64	18	50	60	46
FXE-M 400/50+	1061 0411	400	15	294	95	83	4	50+	14	16
FXE-M 600/50+	1061 0611	600	15	420	95	83	6	50+	21	20
FXE-M 1000/50+	1061 1011	1000	15	680	95	83	10	50+	36	38
FXE-M 1000/80	1061 1002	1000	25	228	228	89	4	80	36	30
FXE-M 2500/80	1061 2502	2500	25	506	228	89	10	80	86	70
FXE-M 4000/80	1061 4002	4000	25	783	228	89	16	80	140	107
FXE-M 1600/100	1061 1603	1600	35	295	296	125	4	100	58	72
FXE-M 2400/100	1061 2403	2400	35	415	296	125	6	100	87	104
FXE-M 3200/100	1061 3203	3200	35	536	296	125	8	100	112	138
FXE-M 4800/100	1061 4803	4800	35	778	296	125	12	100	168	196
FXE-M 7200/100	1061 7203	7200	35	778	415	125	18	100	252	286

Please note declaration for pole structure characteristics page 25 •  
 Workpiece temperature up to 100°C • Optionally with pole shoes for Round material, Profiles, hot Workpieces available • at switching frequency >3/min please query

Model	Voltage (V)	Power (kVA) Impulse	Ohm resistor	Lifting power EN13155 (kg)	clamping surface mm
FXE-M 150/50	380-480	0,6	12,5	150	116x52
FXE-M 300/50	380-480	1,2	25	300	116x116
FXE-M 400/50	380-480	1,2	25	400	244x52
FXE-M 500/50	380-480	1,8	16	500	180x116
FXE-M 600/50	380-480	1,8	16	600	372x52
FXE-M 750/50	380-480	2,4	12,5	750	244x116
FXE-M 1000/50	380-480	3	10,2	1000	628x52
FXE-M 1100/50	380-480	3,6	7,8	1100	372x116
FXE-M 1600/50	380-480	5,4	5,3	1600	564x116
FXE-M 400/50+	380-480	2,4	12,5	400	244x52
FXE-M 600/50+	380-480	3,6	7,8	600	372x52
FXE-M 1000/50+	380-480	6	5,2	1000	628x52
FXE-M 1000/80	380-480	4,8	6,6	1000	172x172
FXE-M 2500/80	380-480	10	2,6	2500	448x172
FXE-M 4000/80	380-480	16	1,9	4000	724x172
FXE-M 1600/100	380-480	12	2,6	1600	222x222
FXE-M 2400/100	380-480	16	1,9	2400	342x222
FXE-M 3200/100	380-480	2x12	2x2,6	3200	462x222
FXE-M 4800/100	380-480	2x16	2x1,9	4800	702x222
FXE-M 7200/100	380-480	3x16	3x1,9	7200	702x342

\* Optionally available in 200-230 V protective earthing, IP 55

FXE-M modules are supplied with rear threads for mechanical recording and ready for connection. Connection box with cable, optionally, we offer the following accessories .

Article	Item-Nr.
Eyelet 250kg	9 1061 0001
Eyelet 600 kg	9 1061 0002
Eyelet 1600 kg	9 1061 0003
Eyelet 3200 kg	9 1061 0004
hanging plate 7,2t	9 1061 0005
Spiral cable 3x2.5 1-5m	1013 5325
Spiral cable 3x2.5 0,5-2m	1013 5326
Spiral cable 4x4mm <sup>2</sup> 1-5m	1013 626



## FXE-MP Electro-Permanent Lifting Magnet Systems

FXE MP electro-permanent lifting magnet modules operate in contrast to the FXE-M Modules not with Square pole but in sandwich construction, which allows particularly narrow and smaller magnet shapes. FXE-MP modules are suited for gripping small components of devices. The magnet modules can be controlled via the control unit MCF.

In use in cranes, manipulators, robots and conveyors to FXE MP modules have proven thousands of times.



Model	Item-Nr.	Max. Load capacity		Dimensions (mm)			Number Poles °N	Breakaway (kN)	Weight (kg)
		(kg)	from (mm)	L	W	H			
FXE-MP 75	1065 0075	75	12	80	80	80	2	2,5	3
FXE-MP 100	1065 0100	100	12	130	45	80	2	3,5	3
FXE-MP 100+	1065 0101	100	15	100	50	90	2	3,5	3
FXE-MP 300	1065 0300	300	20	210	70	110	2	10	9
FXE-MP 500	1065 0500	500	25	270	70	110	2	17	12

Workpiece temperature up to 100°C • Optionally with pole shoes for Round material, Profiles, hot Workpieces available • at switching frequency >3/min please query



The positioning of the socket is variable



## MCF Control Unit

The MCF control units are designed to operate electro-permanent magnet modules. It stands as a single board for installation in the customer's existing control cabinets, as well as IP 54 cabinet solution.

Other e-perm magnetic components except the FXE Lifting magnets modules can be driven with the MCF such as clamping plates or clamping blocks, both construction and simple system (Alnico) as well as in construction as a double system (Alnico/ND).

Power and communication parameters of the MCF can be factory set customer-specifically, it can be driven individual magnets and groups, with partial and full magnetization.

Floating outputs and signal outputs provide feedback on the control position and ensure a very high safety standard. An on-board power control system checks in each cycle if sufficient power is taken from the magnetic module.

The control of the MCF can be done via a machine control, wireless remote control, hand switch or potential-free contacts.

MCF single- and multichannel controllers in IP54 industrial version are made as standard equipment or in custom configuration.



Model	Item-Nr.	LxWxH (mm)	Weight (kg)
MCF PCB without power unit to Pole reversal device	9050 1310	200x120x60	0,4
MCF Power unit	9050 1311	120x50x50	0,2
MCF 1-Channel Pole reversal device	9050 1312-1	300x200x120	6,5
MCF 2-Channel Pole reversal device	9050 1312-2	400x200x120	8,5
MCF 3-Channel Pole reversal device	9050 1312-3	400x300x120	6,5
MCF 4-Channel Pole reversal device	9050 1312-4	400x300x120	12,5
Radio remote control	1013 6001	40x80x14	0,3
LED 360° Signal tower	1013 0026-1	Ø 50x280	1

## Magnetic Lifting



FXE HV device for horizontal/vertical lifting



FXE with custom hand guide handle



FXE with pole shoe for railway wheels



FXE with pole shoe for impellers



FXE long guide column for the removal of wire baskets



FXE-R 5t



FXE-T to move thin sheet



FXE 350-S with One-Hand Control



FXE with Special Control



FXE-T Electro-Permanent Deep-Field Truss



FXE-T with handle for metal strips and beams



FXE-T for Coils



FXE-T for hot slabs



**FXE-T for 8m Sheet Length**



**Extendable to X meters**



**FXE-T 4t**



**FXE-T 12t**

## SML / SMH Electro-Permanent Lifting Magnets

SML/SMH electro-permanent magnets in square pole technology are the safe solution for loads up to 25t and frequent handling. The self-contained unit is supplied with mains voltage and is thus quick to install. The magnet system can be switched on the unit or the remote control supplied.

Innovative control technology ensures maximum safety:

- PICKUP / FULLMAG - the full magnetic power switches shortly after lifting and then provides guaranteed maintenance
- Remote Control – puts the operator in a safe distance to the load
- Holding force regulating – the optimal transport of plates
- DAUTANAC – demagnetization only at no-load chain
- UCS – current control system, verifies the magnetic saturation
- LEDs – always informs you about the switching state



## SML Electro-Permanent Lifting Magnet

SML Lifting-Magnets to handle sheets or blocks with a small air gap. The electro -permanent type SML modules provide a simple solution for transporting loads with a small air gap. Very good balance between load and its own weight. SML magnets provide best services in material storage and when cutting.



Model	Item-Nr.	Dimensions (mm)					Weight (kg)
		A	B	C	D	E	
SML 50	1014 050	1070	760	620	180	100	500
SML 100	1014 100	1140	950	830	266	133	700
SML 150	1014 150	1140	1350	1200	266	133	1000

Model	Strength (mm)	Length (min. mm)	Characteristics of the Loads			Load (max. kg)
			Length (max. mm)	Width (min. mm)	Width (max. mm)	
SML 50	8	1000	5000	1000	2500	5000
SML 100	8	1000	5000	1000	2500	10000
SML 150	8	1000	5000	1000	2500	15000

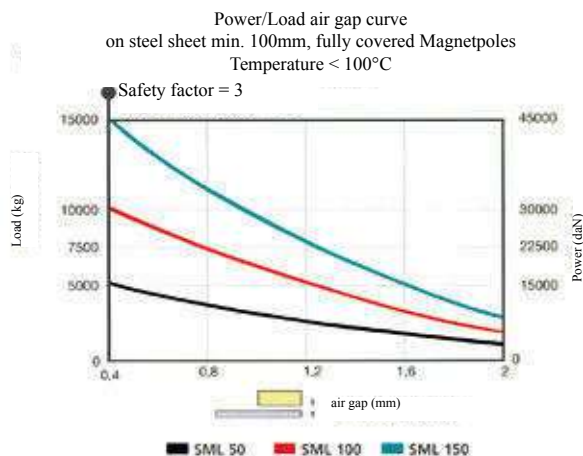
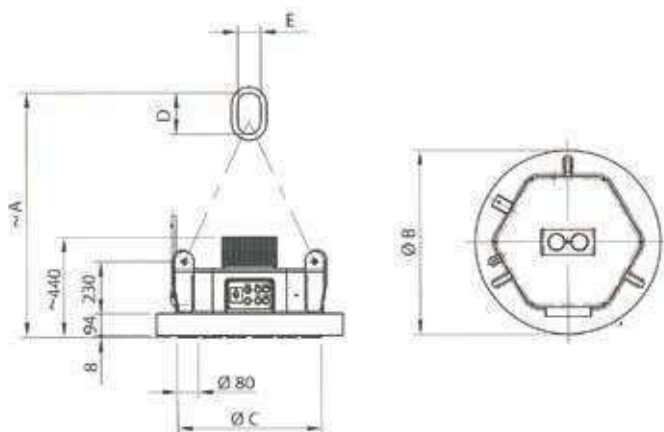

## SMH Electro-Permanent Lifting Magnet

SMH Lifting magnets for handling slabs and blocks. The electro -permanent type SMH modules are designed for transporting loads with large air gaps.



Model	Item-Nr.	Dimensions (mm)										Weight (kg)
		A	B	C	D	E	F Ø	G	H	I	L	
SMH 50	1015 050	1285	505	155	198	462	800	180	100	15	-	610
SMH 100	1015 100	1445	531	181	242	560	880	266	133	15	-	950
SMH 150	1015 150	1475	563	213	280	626	860	266	133	15	997	1300
SMH 200	1015 200	1760	577	227	320	706	980	304	152	15	1117	1750
SMH 250	1015 250	1790	637	280	350	770	1100	355	177	18	-	2150
SMH 300	1015 300	1790	625	272	374	814	1147	355	177	18	1311	2700

Model	Characteristica of the Loads					
	Strength (mm)	Length (min. mm)	Length (max. mm)	Width (min. mm)	Width (max. mm)	Load (max. kg)
SMH 50	30	1000	6000	1000	2500	5000
SMH 100	30	1000	6000	1000	2500	10000
SMH 150	40	1000	6000	1000	2500	15000
SMH 200	40	1000	6000	1000	2500	20000
SMH 250	80	1000	6000	1000	2500	25000
SMH 300	80	1000	6000	1000	2500	30000

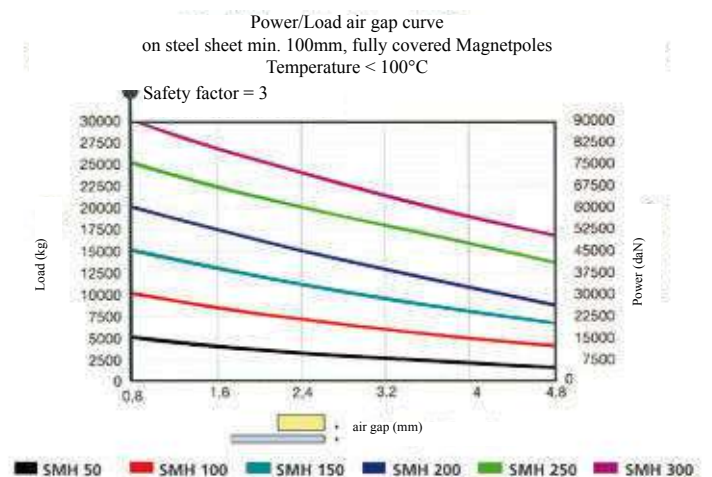
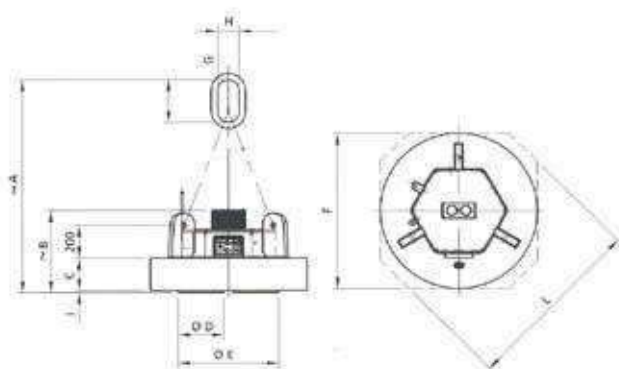

## BF 2 Electro-Permanent Magnetic Truss

BF2 magnetic trusses are designed for the handling of large metal sheets and panels, especially in the Storage and before cutting. 4 Magnet modules are permanently installed on a rigid cross-member. The self-contained unit is supplied with mains voltage and is thus quick to install. The magnet system can be switched to the crossbar or on the remote control supplied.

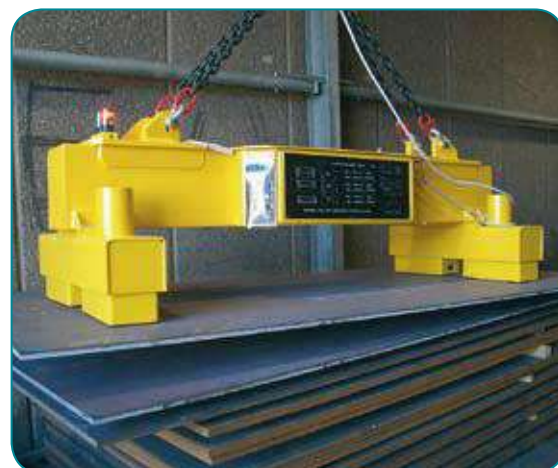

Innovative control technology ensures maximum safety:

- PICKUP / FULLMAG - the full magnetic power switched shortly after lifting and then provides guaranteed maintenance
- Remote Control – puts the operator in a safe distance to the load
- Holding force regulating – the optimal transport of plates
- DAUTANAC – demagnetization only at no-load chain
- UCS – current control system, verifies the magnetic saturation
- LEDs – always informs you about switching status



Model	Item-Nr.	Load properties					Weight (kg)	
		thickness		Length		width		
		min. (mm)	min. (mm)	max. (mm)	min. (mm)	max. (mm)		Load-capacity (kg)
BF 2-35	1016 237	5	3200	6000	500	3000	3500	1100
BF 2-60	1016 260	5	3200	6000	500	3500	6000	1100
BF 2-90	1016 290	8	3200	6000	500	3500	9000	1350

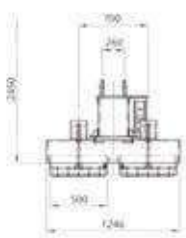
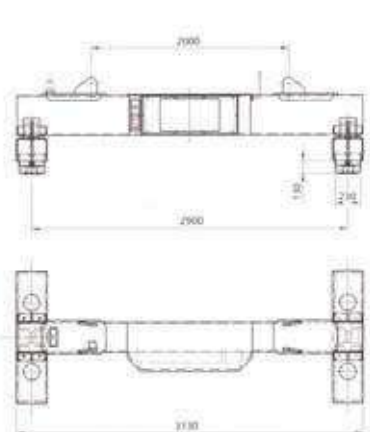

Power/Load air gap curve on steel sheet min. 30mm, fully covered Magnetpoles Temperature < 100°C

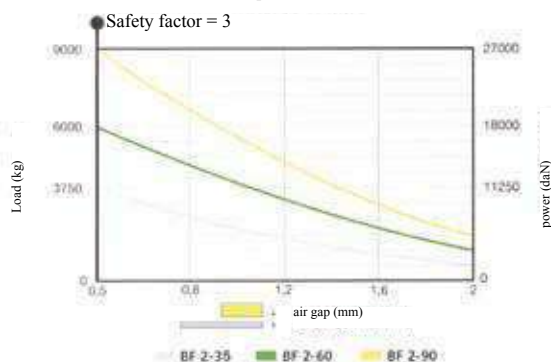



## TM 4 Elektro-Permanent Magnetic Truss

TM 4 Magnetic-Trusses with electro-hydraulic telescopic arms are suitable for sheets of 3 - 12m length to lift safely. 2 fixed and 2 movable transverse trusses are equipped with 2 magnetic modules. The length of the traverse is between 5800mm and 8800mm changeable via remote control. The self-contained unit is supplied with mains voltage and is thus quick to install. The magnet system can be switched to the crossbar or on the remote control supplied.



Innovative control technology ensures maximum safety:

- PICKUP / FULLMAG - the full magnetic power shortly after Lifting switched and then provides guaranteed maintenance
- Remote Control – puts the operator in a safe distance to the load
- Holding force regulating – the optimal transport of plates
- DAUTANAC – demagnetization only at no-load chain
- UCS – current control system, verifies the magnetic saturation
- LEDs – always informs you about the switching state

Model	Item-Nr.	Load properties					Weight (kg)	
		thickness		Length	Width			Load-capacity (kg)
		min. (mm)	min. (mm)	max. (mm)	min. (mm)	max. (mm)		
TM 4-75	1019 40750	5	3000	12000	500	3500	7500	2800
TM 4-100	1019 41000	5	3000	12000	500	3500	10000	2800
TM 4-120	1019 41200	5	3000	12000	500	3500	12000	2800
TM 4-140	1019 41400	8	3000	12000	500	3500	14000	2800
TM 4-180	1019 41800	8	3000	12000	500	3500	18000	2800

Larger Models up to 18m Length on request

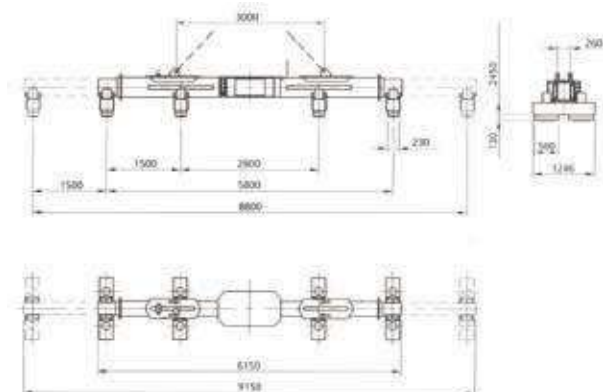

Power/Load air gap curve  
on steel sheet min. 30mm, fully covered Magnetpoles  
Temperature < 100°C

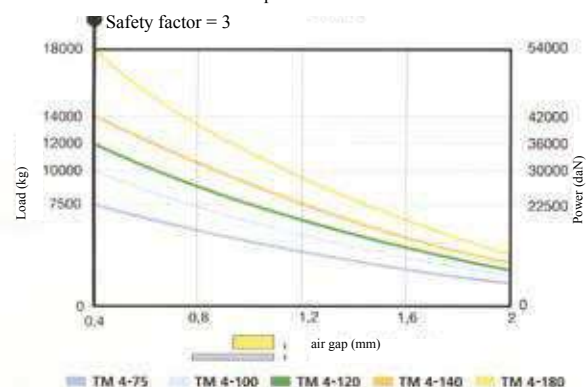

## EPM-MHN Electro-Permanent Lifting Magnet

EPM-MHN Lifting-Magnets are an option for the rapid handling of loads up to 150 kg. By mains plug fully assembled onboard control the handy device is ready for use very quickly. The mono-stable permanent magnet system is demagnetized by pressing the control key when applying and releasing. It is holding the load safely during transport and power failure. By building application-specific pole pieces round or profiled workpieces can be lifted.

The Version EPM-MHN 150+ with one-hand switch is the ergonomic solution for continuous use.



Model	Item-Nr.	Max. rec. Load-capacity (kg)		Abmessungen (mm)				Breakaway (kN)	Voltage	Weight (kg)
		—	from Material thickness	L	W	W with handle	H			
EPM-MHN 150+	1020 1502	150	12 mm	170	85	-	300	6	230 V	10

Max. Off-time 30% - 30min • Workpiece temperature to 80°C

## ERM Electro Collecting-Magnet

ERM Electric round magnets for lifting parts by mass, bulk and occasional sorting magnetizable parts. ERM are equipped with top-mounted switch and integrated rectifier, for direct connection to 230 V mains voltage. The depth of field is approximately 80-120 mm. Not permitted for transporting massive workpieces in unsecured areas.



Model	Item-Nr.	Dimensions (mm)		coil Power	Supply voltage	Performance (W)	Weight (kg)
		Ø	W				
ERM 20	1010 20	200	80	110 V	230 V	130	15
ERM 25	1010 25	250	100	110 V	230 V	220	28
ERM 30	1010 30	300	120	110 V	230 V	370	48
ERM 40	1010 40	400	120	110 V	230 V	600	84

100% ED at 20°C • Other dimensions on request  
Square shape possible on request!

## NER Electro Collecting-Magnet

Electric rotary magnet for installation in handling equipment, in connection with an external power supply or a pole-reversal-device.



EHG Electro rectangle-Magnets, sizes, voltage and Duty are customized.

Model	Item-Nr.	Dimensions (mm)		Breakaway at VDE 0580	coil Power	Performance (W)	Weight (kg)
		Ø	W				
NER 20	1010 21	200	80	12 kN	110 V	130	15
NER 25	1010 26	250	100	22 kN	110 V	220	28
NER 30	1010 31	300	120	36 kN	110 V	370	48
NER 40	1010 41	400	120	50 kN	110 V	600	84

100% ED bei 20°C • Andere Abmessungen auf Anfrage

## POLE REVERSAL DEVICES for Collecting-Magnets

Using Pole Reversal Devices for driving collecting magnets makes it possible to adjust the magnetic field very accurately. Thus, the USG can be continuously regulated in the holding force and run when you turn off a demagnetizing cycle by ensuring that all parts are released and undesired residual magnetism is minimized in the workpiece.

USG Pole Reversal Devices can be controlled with potential free contacts with machine controls or buttons in the crane operation and provide feedback about their switching state.

Optionally, you can also order hand controls and signal lights sets to match the Pole Reversal Devices.



Optional: signal lights and a hand control unit

Model	Item-Nr.	Dimensions (mm)			Output Voltage*	max. Output	Connection	Weight (kg)
		L	B	T				
Pole Rev. Device USG-TG IP 54	1013 5004	300	300	200	0-110V DV	440 W	230V / 50Hz	14
Pole Rev. Device USG-TG IP 54	1013 5015	460	300	160	0-110V DC	1650 W	230V / 50Hz	9

\* also available in other Voltage

### FBM Battery Lifting Magnets

Battery Lifting magnets are location-independent and flexible as permanent lifting magnets and at the same time have the advantage of remote control capability and usability of a button. They are mainly used in applications where higher loads are handled continually, since they can be connected without any physical effort. Another common application is in poor accessibility of the contact point. All our battery lifting magnets are equipped with IR remote control and high-quality, over-discharge proof gel battery. FBM lifting magnets in accordance with the latest standards and have been designed according to the main criteria of safety and ease of use.



Many thoughtful details ensure maximum safety:

- A Lifting eye sensor prevents turning off a floating magnet.
- Two push buttons for the command “release”
- Audible alarm and flashing light to indicate a too low charge level
- The magnet may not be switched on at too low battery voltage
- LED indicator to check the battery levels
- Meets the latest national and international safety standards



## FBM Battery Lifting Magnets



The FBM series is suitable for handling flat material. FBM 13, FBM 25, FBM 50 were specially designed for lifting heavy, thick blocks and sheets. To achieve the maximum holding force, at least 50 mm thickness and a suitable surface are needed. FBM 36 was specifically designed for lifting sheets from 3 mm thickness. With a clean and smooth surface this magnet holds at 3mm material thickness of a metal plate 2,4x1,8m and 25 mm material thickness even a panel of 6x3m. The optional "accessory system typing" facilitates the removal of thin sheets from a stack.

Model	Item-Nr.	Max. rec. Load-capacity (kg)		Dimensions (mm)			discharge 50% ED	Weight (kg)
		—	●	L	W	H		
FBM 13	1011 13	1350	-	272	242	460	8h	60
FBM 25	1011 25	2500	-	400	242	460	8h	72
FBM 36	1011 36	3600	-	1050	240	460	8h	180
FBM 50	1011 50	5000	-	1200	300	460	8h	203

Safety factor of 2, determined on a workpiece of suitable thickness and surface!  
Loadtables on Page 66!

## FBM-P Battery Lifting Magnets



The Series FBM-P with Prism is suitable for flat, round and profile material. FBMP 18 and 36 have special FBM-P prism-pole-pieces which enable the lifting of flat and round material and profile materials such as carriers or angle iron. The maximum capacity is achieved with materials from 50 mm thickness. The particularly low magnetic field of these models ensures a secure grip even in poor surfaces.

Model	Item-Nr.	Max. rec. Load-capacity (kg)		Dimensions (mm)			discharge 50% ED	Weight (kg)
		—	●	L	W	H		
FBM-P 18	1012 18	1800	Ø 25-300 mm 1130 kg	470	242	610	8h	167
FBM-P 36	1012 36	3600	Ø 25-300 mm 2260 kg	760	262	620	8h	420

Safety factor of 2, determined on a workpiece of suitable thickness and surface!  
Loadtables on Page 66!

## DINAKSA Load Measuring Systems

Working with the crane requires precision and safety. Crane load measuring systems from the house DINAKSA you are prepared. Measuring systems of DINAKSA leave nothing to be desired. All systems communicate together to form a self-contained circuit, which provides the user at any time reliable and accurate information.

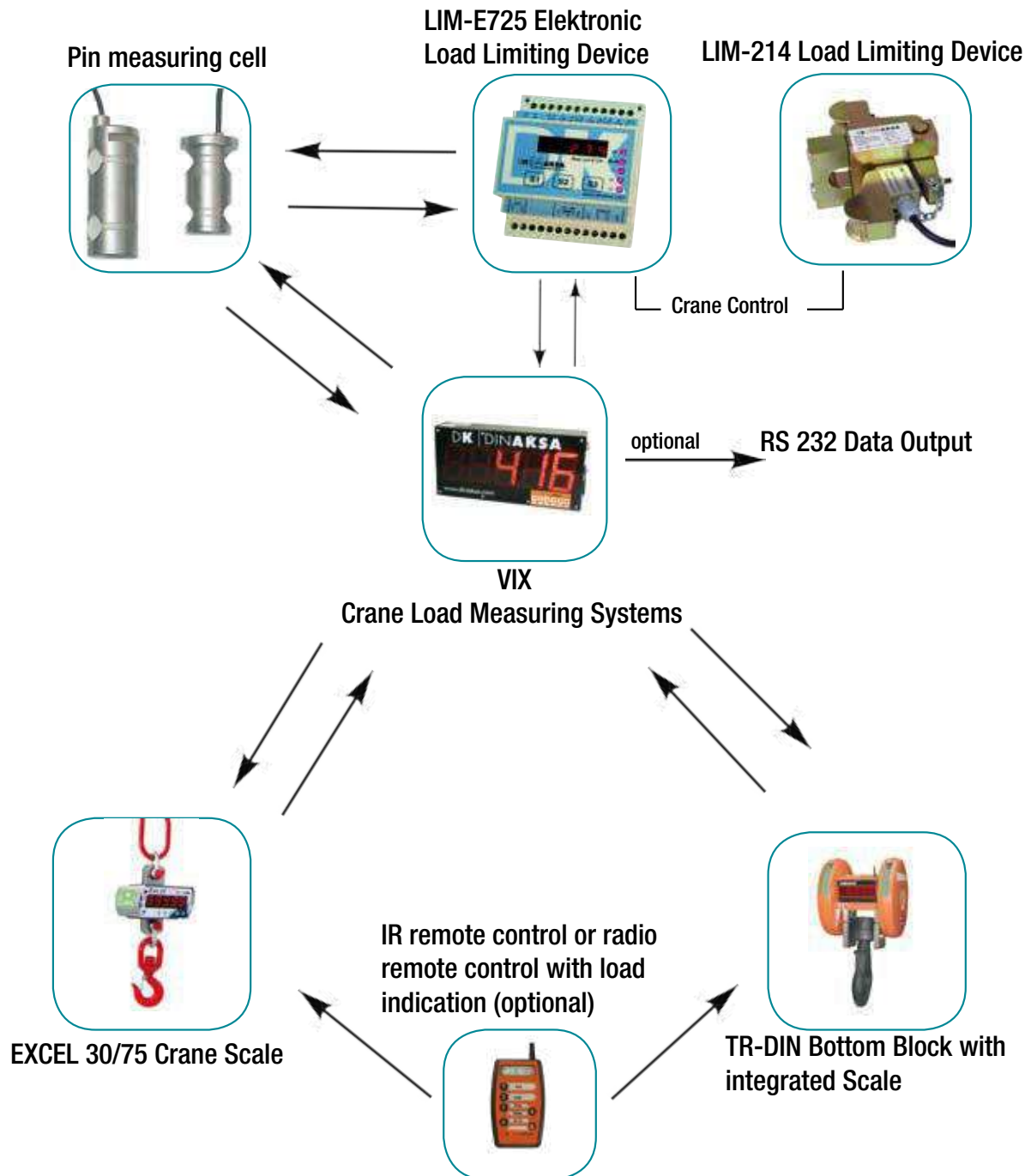

All systems are Class III according to 2014/31/EU, SOLAS capable

## EXCEL Crane Scales

EXCEL crane scales work with precision technology in stainless steel housing, which ensures the highest reliability, even under harsh working conditions. The intelligent electronic measuring system provides accurate results, even with a low stability of the load.

In developing the Excel was paid to ease of use. So it comes with the push-buttons "ON/OFF", "Tara" and "zero". This ensures an easy and quick application. EXCEL crane scales are generally equipped with LED lights up red indicator and thus provide even in dark halls, in low light conditions and unfavorable angle still easy to read measurements. EXCEL crane scales are a European quality product from Dinaksa. The experience of over 30 years weighing and lifting technology is reflected in its intelligent structure.

### Technical Specification

- Standard equipment for measuring ranges from 300-10.000kg
- LED display with red indicator - The 5 digits have a height 30mm or 75mm
- Stainless steel case
- accuracy of  $\pm 0.03\%$  of the maximum capacity
- Operating temperature  $-20$  to  $+70^{\circ}\text{C}$
- Sealed to IP55
- 5 Status indicators - (zero stability, Tara, negative, battery)
- Long battery life including AUTO-charger
- Supplied accessories: Ring, 2 load shackle, hooks with Lock, charger

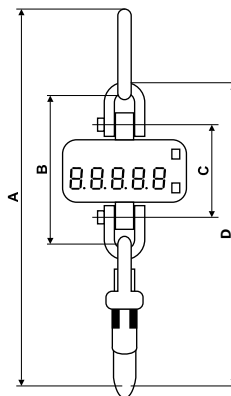

More Options on request!

Model 30 Digit Height 30mm	Item-Nr.	Measuring range (kg)	Display step (kg)	Dimensions (mm)				Weight (kg)
				A	B	C	D	
EXCEL 300	8012 00300	300	0,1	500	235	370	400	4
EXCEL 500	8012 00500	500	0,1	500	235	370	400	4
EXCEL 1000	8012 01000	1000	0,2	500	235	370	400	5
EXCEL 2000	8012 02000	2000	0,5	550	260	370	400	5
EXCEL 3200	8012 03200	3200	0,5	570	265	440	430	6
EXCEL 5000	8012 05000	5000	1,0	700	330	535	595	11
EXCEL 6300	8012 06300	6300	1,0	770	335	535	600	14
EXCEL 10000	8012 10000	10000	2,0	840	350	610	710	21

Weight with shackles, hooks and eyes

Model 75 Digit Height 75mm	Item-Nr.	Measuring range (kg)	Display step (kg)	Dimensions (mm)				Weight (kg)
				A	B	C	D	
EXCEL 3150	8022 03150	3150	0,5	570	260	400	430	9
EXCEL 6300	8022 06300	6300	1,0	770	330	500	600	17
EXCEL 9500	8022 09500	9500	2,0	840	335	465	710	25
EXCEL 12000	8022 12000	12000	5,0	900	350	540	710	28
EXCEL 15000	8022 15000	15000	5,0	1050	360	635	775	45
EXCEL 22000	8022 22000	22000	10,0	1300	580	890	990	72
EXCEL 25000	8022 25000	25000	10,0	1375	580	890	1065	80
EXCEL 31500	8022 31500	31500	20,0	1450	660	980	1130	106

Weight with shackles, hooks and eyes

## TR-DIN Bottom-Blocks with integrated Scales

TR-DIN Bottom-Blocks with integrated scales are an extremely stable and highly accurate alternative to the use of simple crane scales. Because of the crane-integrated bottle measuring cell, the crane system does not lose its hook height. Usually TR-DIN scales are very easy to install. The red, well readable, digital display informs the crane operator continuously and precisely on the current load. For continuous commitment the TR-DIN is supplied with 2 rechargeable batteries and external charger. So the exhausted battery can be replaced in a very short time to the battery located in the charging cradle. Supplied with IR remote control for the commands „TARE“ and „OFF“.

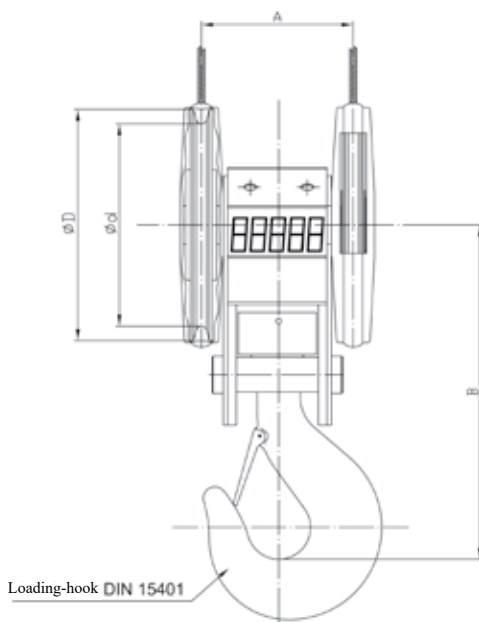

Models with sheave on request

### Technical Details of TR-DIN:

- High precision 0.1 % V.E.
- Large, bright red digital display, with digits from 25-60mm height – depending on the load
- Tare-suppression over the entire measuring range
- Sealed to IP65
- 2 change-battery / external charger
- Operating range from -10°C to +50°C
- Alarm display for overload/Tare/battery



2 Change batteries, charger and IR remote control are delivery included

Model	Item-Nr.	Measuring-range (kg)	display-steps (kg)	display-size (mm)	hook-size to DIN 15401	Dimensions (mm)				rope-Ø (mm)	Weight (kg)
						A	B	D	d		
TR-DIN 2000	8040 0200	2000	0,5	5x20	1,6	169	280	192	160	7-9	16
TR-DIN 3200	8040 0301	3200	1	5x20	1,6	169	280	192	160	7-9	16
TR-DIN 5000	8040 0500	5000	1	5x20	2,5	240	310	240	200	9-11	24
TR-DIN 6300	8040 0630	6300	1	5x20	2,5	240	310	240	200	9-11	24
TR-DIN 8000	8040 0800	8000	2	5x25	5	245	355	355	280	14-17	30
TR-DIN 10000	8040 1000	10000	2	5x25	5	245	355	355	280	14-17	40
TR-DIN 12000	8040 1200	12000	5	5x25	5	245	355	355	280	14-17	40
TR-DIN 16000	8040 1600	16000	5	5x75	8	335	505	415	355	17-19	70
TR-DIN 20000	8040 2000	20000	10	5x75	8	335	505	415	355	17-19	75
TR-DIN 25000	8040 2500	25000	10	5x75	10	355	520	415	355	17-19	95
TR-DIN 32000	8040 3200	32000	10	5x75	12	400	580	520	450	19-21	125

The specified sizes are common standards. Depending on the engine group and type the required device can vary. For precise clarification should be given with inquiries rope diameter sheave diameter, sheave distance and the desired hook size to DIN 15401 and the engine group in accordance with DIN 15411.



## VIX Measuring Systems

Crane load measurement systems VIX measure the actual load on the fixed rope of the crane system. For this purpose a measuring cell is installed shortly after the suspension of the crane rope, or installed a pin measuring cell at the fixed point, or at the upper return pulley of the cable guide. The VIX display unit is permanently connected to the mains voltage and is therefore totally maintenance free. The red light under the digital display is easy to read at a great distance. Optional the measured value can be sent via radio to other ads or a PC interface. Optional multiple relays can be installed at different loads.

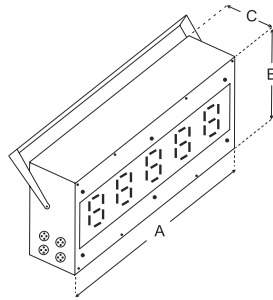

Model	Item-Nr.	Dimensions (mm)			display Nr. x Height (mm)	Weight (kg)
		A	B	C		
VIX 25	8091 0025	201	130	70	5x25	3
VIX 75	8091 0075	201	130	70	5x75	6
VIX 150	8091 0150	518	239	115	5x150	9
VIX 200	8091 0200	950	280	110	5x200	10
VIX 300	8091 0300	1500	420	115	5x300	12
Precision 0,6 % v.E. (at calibration height) Operation-range from -10-+50°C						

### Optional:

- External input for the tare command (to link to the crane control)
- IR remote control for the functions „TARE„ and „OFF“
- Adjustable limit contact / alarm / overload
- Signal amplifiers for distances greater than 10m between measuring cell and VIX
- RS 232 interface
- Integrated printer

## PT Measuring Cells

PT measuring cells installed in the load cable. Pin measuring cells are manufactured individually so that the existing bolt must only be exchanged. They offer the highest reliability and precision.

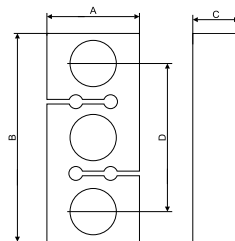

Optional: Pin Measuring Cell

Model	Item-Nr.	Max. Load on rope (kg)	Dimensions (mm)				Length of cable (m)
			A	B	C	D	
PT 1500	8081 0150	1500	50	110	24	25	4
PT 3000	8081 0300	3000	60	140	30	90	4
PT 5000	8081 0500	5000	70	180	34	120	4
PT 10000	8081 1000	10000	100	220	48	130	5
PT 15000	8081 1500	15000	125	250	68	155	8

## LIM-E725 Electronic Load Limiting Device

The electronic load limiting LIM-E725 impresses with compact design, flexible, diverse Applications and ease of use and is easy to install as a series configuration device. It is suitable for overload shutdown (Mandatory according to European standard since 1992), lashing rope inspection or signal relay for detecting freely programmable loads.

### Application

The LIM-E725 is designed for use in connection with electronic load cells in cranes, Hoists, conveyors and in automation technology.

Optionally, external displays and other devices such as lighting and sounders are connected



Model	Item-Nr.
Electronic Load Limiting Device LIM-E725	80600725
Operation Temperature -20 - +60°C	

## LIM-214 Load Limiting Device

Load limiting LIM-214 are easily executed and easy to install devices, which are suitable for retrofitting of existing cranes in terms of the European Machinery Directive 89392 /CEE. They have been developed for two and multi-strand electric wire rope hoists up to a maximum carrying capacity of 7/15t per rope. The installation is very simple. The load limiting LIM-214 is clamped to the cable clamp on the fixed rope of the crane system. When exceeding the adjusted load limit of the built-in micro-switch is activated. The load limit is easily adjusted with two screws.



Case material:	Steel, chromated yellow
Operation temperature:	-30°C to +60°C.
Precision:	± 1% v.E.
Protection:	IP 54

Model	Item-Nr.	Dimensions (mm)			Max. Load (kg)	Max. rope-Ø (mm)	Contacts	Weight (kg)
		L	B	H				
LIM-214	8060 214	140	150	70	7000	28	1 Wechsler 4 A / 250 V	4
LIM-201 BIG	8060 202	140	150	70	15000	40	1 Wechsler 4 A / 250 V	9
LIM-201 BIG / 2	8060 203	140	150	70	15000	40	2 Wechsler 4 A / 250 V	9,2

When ordering the steel rope diameter and the load is adjusted to indicate

## Factors affecting the Holding powers of Lifting magnets

For choosing the right lifting magnet model five other factors to consider that affect the lifting force other than the weight of the load:

### 1. The contact surface

If a distance (air gap) exists between the lifting magnet and the load to be lifted, the magnetic flux is made more difficult and thus reduces the lifting capacity. Rust, paint, dirt, paper or rough machined surface can have such an air gap result and in turn mean a reduction in the lifting force.

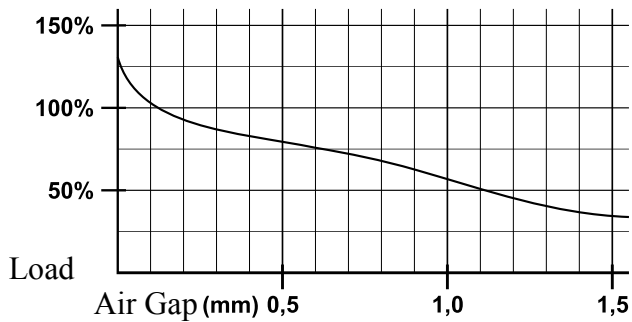

### 2. Material thickness

The magnetic flux of the lifting magnets requires a minimum material thickness. If the workpiece does not reach this minimum thickness, the lifting force is smaller. For larger lifting benefits greater material thicknesses are required.

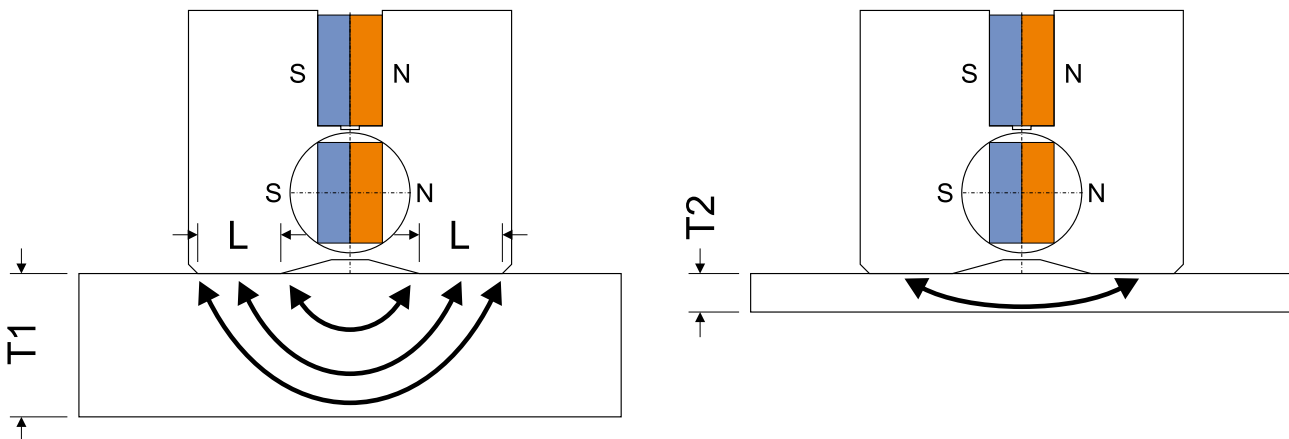

### 3. Workpiece dimensions / intrinsic stability

If the length or width of the load is larger, the workpiece sags and is formed between the lifting magnet and the load - especially at low material thicknesses - an air gap. This reduces the lifting force of the lifting magnets.

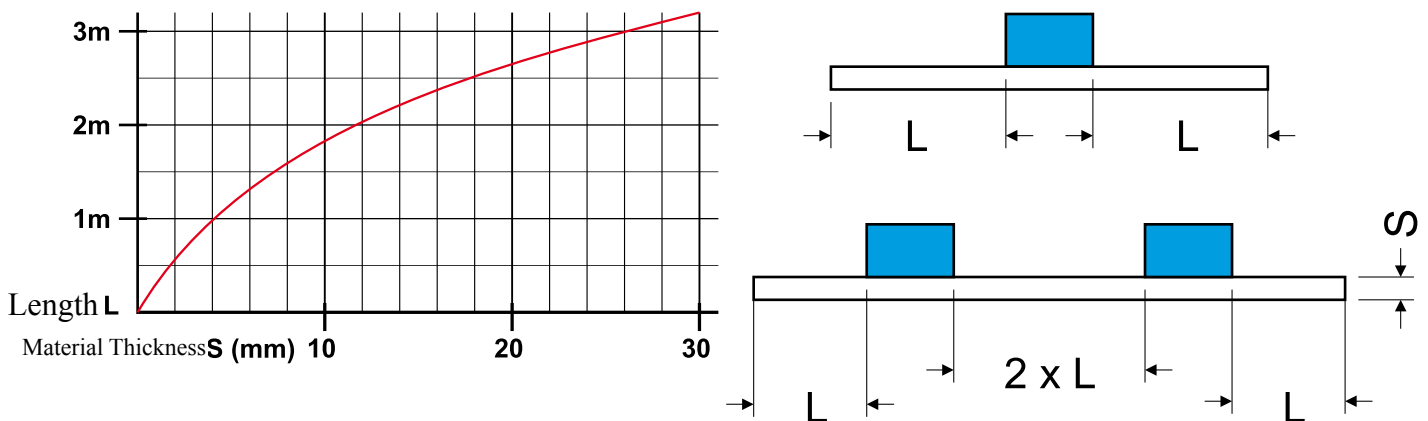

## Factors affecting the Holding powers of Lifting magnets

### 4. Composition of the Load to be lifted

Steel with low carbon content is a good magnetic conductor eg F1110 or St37. Steel alloy with a high carbon content or with other materials such as steel loses its magnetic properties so that the power of the lifting magnets is low. Heat treatments which affect the steel structure also reduce the lifting power. The harder a steel the worse its response to magnets, and it tends to retain a residual magnetism. The nominal power of our lifting magnets is valid for a steel with low carbon content, such as C 40 / St37.

Material	Lifting power (%)
Carbon Steel 0,1 - 0,3 % C ST37/52	100
Carbon Steel 0,4 - 0,5 % C	90
Alloy Steel 2312/2379...	80 - 90
cast iron GGG	70 - 80
cast iron GG	45 - 60
Alloy Steel hardened at 55-60 HRc	40 - 50
Stainless Steel	0
Brass, Aluminum, Copper	0

### 5. Temperature of the Load to be lifted

The higher the temperature the faster the molecules vibrate the steel. Quick vibrating molecules provide the magnetic flux higher resistance. Our data apply to max. 80 °C.

In almost the same way, the factors making 1,2,4,5 also noticeable in the magnetic clamping.

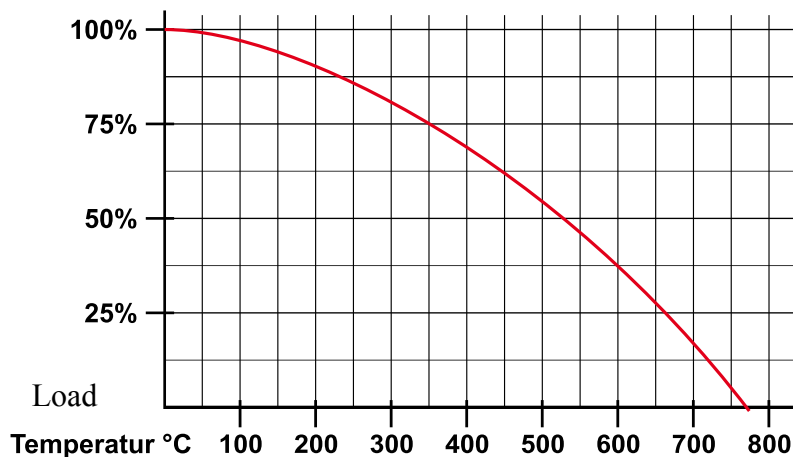

## FX Force / Load / Air Gap

FX 150	Air gap < 0,1mm			Air gap 0,1 - 0,3 mm			Air gap 0,3 - 0,5 mm		
Material thickness (mm)	Max. Load (kg)	Max. L (mm)	Max. W (mm)	Max. Load (kg)	Max. L (mm)	Max. W (mm)	Max. Load (kg)	Max. L (mm)	Max. W (mm)
>= 2	20	800	800	12	800	800	10	800	800
>= 4	60	1500	1000	40	1500	1000	30	1200	1000
>= 6	80	1500	1000	60	1500	1000	50	1200	1000
>= 8	150	1500	1000	120	1500	1000	80	1200	1000
Ø50-200	75	1500	1000	50	2000	-	40	1500	-

FX 300	Air gap < 0,2mm			Air gap 0,2 - 0,3 mm			Air gap 0,3 - 0,6 mm		
Material thickness (mm)	Max. Load (kg)	Max. L (mm)	Max. W (mm)	Max. Load (kg)	Max. L (mm)	Max. W (mm)	Max. Load (kg)	Max. L (mm)	Max. W (mm)
>= 4	60	1600	1000	50	1500	1000	40	1250	1000
>= 8	200	2000	1250	160	2000	1250	120	1500	1000
>= 10	230	2250	1250	190	2000	1250	150	1500	1000
>= 15	300	2500	1250	250	2000	1250	200	1500	1000
Ø50-300	150	3000	-	125	2500	-	100	2000	-

FX 600	Air gap < 0,2mm			Air gap 0,2 - 0,3 mm			Air gap 0,3 - 0,6 mm		
Material thickness (mm)	Max. Load (kg)	Max. L (mm)	Max. W (mm)	Max. Load (kg)	Max. L (mm)	Max. W (mm)	Max. Load (kg)	Max. L (mm)	Max. W (mm)
>= 6	150	1800	1500	120	1800	1250	100	1500	1250
>= 10	300	2250	1500	250	2250	1250	210	2000	1250
>= 15	500	2500	1500	440	2500	1250	350	2000	1250
>= 20	600	3000	1500	520	3000	1250	440	2500	1250
Ø80-400	300	4000	-	250	3500	-	200	3000	-

FX 1000	Air gap < 0,3mm			Air gap 0,3 - 0,5 mm			Air gap 0,5 - 0,6 mm		
Material thickness (mm)	Max. Load (kg)	Max. L (mm)	Max. W (mm)	Max. Load (kg)	Max. L (mm)	Max. W (mm)	Max. Load (kg)	Max. L (mm)	Max. W (mm)
>= 10	350	2250	1500	300	2250	1500	260	2250	1250
>= 15	600	2500	1500	500	2500	1500	450	2500	1250
>= 20	900	3000	1500	750	3000	1500	675	3000	1250
>= 25	1000	3500	1500	850	3000	1500	750	3000	1250
Ø100-450	500	4500	-	400	4000	-	330	3000	-

FX 2000	Air gap < 0,3mm			Air gap 0,3 - 0,6 mm			Air gap 0,6 - 0,8 mm		
Material thickness (mm)	Max. Load (kg)	Max. L (mm)	Max. W (mm)	Max. Load (kg)	Max. L (mm)	Max. W (mm)	Max. Load (kg)	Max. L (mm)	Max. W (mm)
>= 15	500	2500	2000	400	3000	2000	330	2500	1500
>= 25	1200	3000	2000	950	3000	2000	800	3000	1500
>= 40	1600	2500	2000	1300	3000	2000	1100	3000	1500
>= 50	2000	4000	2000	1600	3000	2000	1300	3000	1500
Ø120-600	1000	4500	-	800	4000	-	650	3500	-

FX 3000	Air gap < 0,3mm			Air gap 0,3 - 0,6 mm			Air gap 0,6 - 0,8 mm		
Material thickness (mm)	Max. Load (kg)	Max. L (mm)	Max. W (mm)	Max. Load (kg)	Max. L (mm)	Max. W (mm)	Max. Load (kg)	Max. L (mm)	Max. W (mm)
>= 15	750	2500	2500	600	3000	2500	500	2500	2000
>= 25	1800	3000	2500	1400	3000	2500	1200	3000	2000
>= 40	2400	3500	2500	2000	3000	2500	1600	3000	2000
>= 50	3000	4000	2500	2400	3000	2500	2000	3000	2000
Ø120-600	1500	5000	-	1200	5000	-	1000	4000	-

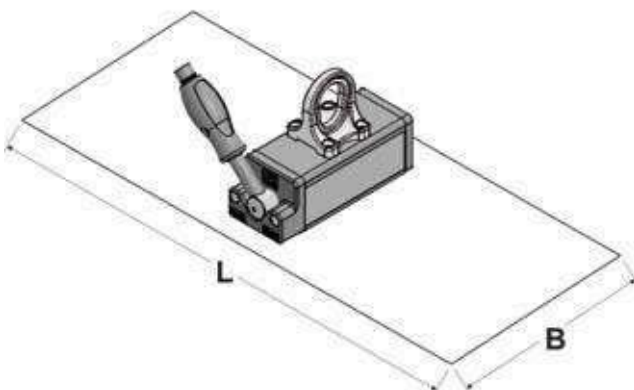

## FX-R Force / Load / Air Gap

FX-R100	Air gap < 0,1mm			Air gap 0,1 - 0,3 mm			Air gap 0,3 - 0,5 mm		
Material thickness (mm)	Max. Load (kg)	Max. L (mm)	Max. W (mm)	Max. Load (kg)	Max. L (mm)	Max. W (mm)	Max. Load (kg)	Max. L (mm)	Max. W (mm)
>= 2	25	800	800	12	800	800	10	800	800
>= 4	50	1500	1000	40	1500	1000	30	1200	1000
>= 6	70	1500	1000	60	1500	1000	45	1200	1000
>= 8	100	1500	1000	75	1500	1000	60	1200	1000
Ø25-150	100	2000	-	75	2000	-	60	1500	-

FX-R225	Air gap < 0,2mm			Air gap 0,2 - 0,3 mm			Air gap 0,3 - 0,6 mm		
Material thickness (mm)	Max. Load (kg)	Max. L (mm)	Max. W (mm)	Max. Load (kg)	Max. L (mm)	Max. W (mm)	Max. Load (kg)	Max. L (mm)	Max. W (mm)
>= 4	80	1600	1000	60	1500	1000	40	1250	1000
>= 8	180	2000	1250	150	2000	1250	120	1500	1250
>= 10	225	2250	1250	200	2000	1250	150	1500	1250
Ø50-205	225	3000	-	200	2500	-	150	2000	-

FX-R450	Air gap < 0,2mm			Air gap 0,2 - 0,3 mm			Air gap 0,3 - 0,6 mm		
Material thickness (mm)	Max. Load (kg)	Max. L (mm)	Max. W (mm)	Max. Load (kg)	Max. L (mm)	Max. W (mm)	Max. Load (kg)	Max. L (mm)	Max. W (mm)
>= 6	150	1800	1500	120	1800	1000	100	1500	1250
>= 10	300	2250	1500	250	2250	1250	210	2000	1250
>= 15	400	2500	1500	350	2500	1250	300	2000	1250
>= 20	450	3000	1500	400	3000	1250	350	2500	1250
Ø50-270	450	4000	-	375	3500	-	280	3000	-

FX-R750	Air gap < 0,3mm			Air gap 0,3 - 0,5 mm			Air gap 0,5 - 0,6 mm		
Material thickness (mm)	Max. Load (kg)	Max. L (mm)	Max. W (mm)	Max. Load (kg)	Max. L (mm)	Max. W (mm)	Max. Load (kg)	Max. L (mm)	Max. W (mm)
>= 8	300	2250	1500	280	2250	1500	250	2250	1250
>= 10	400	2500	1500	380	2500	1500	300	2500	1250
>= 15	700	3000	1500	680	3000	1500	550	3000	1250
>= 20	750	3500	1500	720	3000	1500	600	3000	1250
Ø70-370	750	4500	-	600	4000	-	450	3000	-

FX-R1200	Air gap < 0,3mm			Air gap 0,3 - 0,6 mm			Air gap 0,6 - 0,8 mm		
Material thickness (mm)	Max. Load (kg)	Max. L (mm)	Max. W (mm)	Max. Load (kg)	Max. L (mm)	Max. W (mm)	Max. Load (kg)	Max. L (mm)	Max. W (mm)
>= 15	600	2500	2000	500	3000	2000	440	2500	1500
>= 20	800	3000	2000	650	3000	2000	550	3000	1500
>= 25	1000	3500	2000	800	3000	2000	700	3000	1500
>= 40	1200	4000	2000	1000	3000	2000	900	3000	1500
Ø120-560	1200	4500	-	900	4000	-	700	3500	-

FX-R1800	Air gap < 0,3mm			Air gap 0,3 - 0,6 mm			Air gap 0,6 - 0,8 mm		
Material thickness (mm)	Max. Load (kg)	Max. L (mm)	Max. W (mm)	Max. Load (kg)	Max. L (mm)	Max. W (mm)	Max. Load (kg)	Max. L (mm)	Max. W (mm)
>= 15	900	2500	2000	750	3000	2000	660	2500	1500
>= 20	1200	3000	2000	1000	3000	2000	825	3000	1500
>= 25	1500	3500	2000	1200	3000	2000	1050	3000	1500
>= 40	1800	4000	2000	1500	3000	2000	1200	3000	1500
Ø120-560	1800	5000	-	1500	4000	-	1125	3500	-

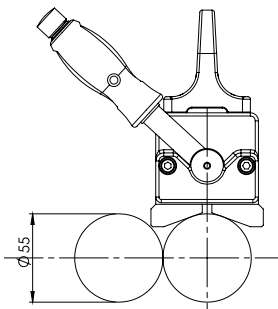

FX-R100

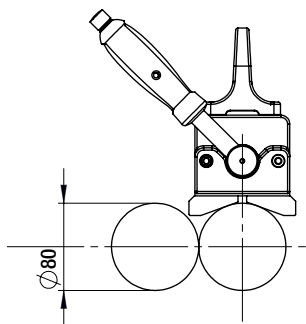

FX-R225

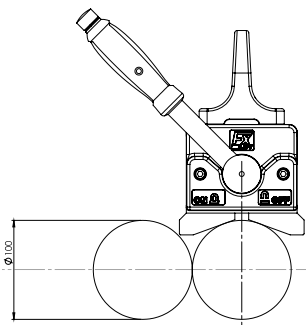

FX-R450

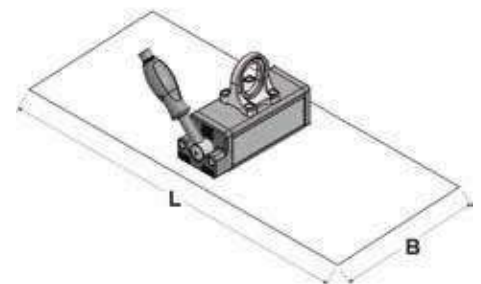

## FX-P Force / Load / Air Gap

FX-P170	Air gap < 0,1mm			Air gap 0,1 - 0,3 mm			Air gap 0,3 - 0,5 mm		
Material thickness (mm)	Max. Load (kg)	Max. L (mm)	Max. W (mm)	Max. Load (kg)	Max. L (mm)	Max. W (mm)	Max. Load (kg)	Max. L (mm)	Max. W (mm)
>= 2	30	800	800	20	800	800	15	800	800
>= 4	80	1500	1250	60	1500	1250	50	1200	1250
>= 6	120	1500	1250	90	1500	1250	75	1200	1250
>= 8	170	1500	1250	130	1500	1250	100	1200	1250
Ø30-105	150	2000	-	115	2000	-	60	1500	-

FX-P330	Air gap < 0,2mm			Air gap 0,2 - 0,3 mm			Air gap 0,3 - 0,6 mm		
Material thickness (mm)	Max. Load (kg)	Max. L (mm)	Max. W (mm)	Max. Load (kg)	Max. L (mm)	Max. W (mm)	Max. Load (kg)	Max. L (mm)	Max. W (mm)
>= 4	100	2000	1250	80	1500	1250	60	1250	1250
>= 6	160	2500	1500	130	2000	1500	100	1500	1500
>= 8	300	2500	1500	240	2000	1500	180	1500	1500
>= 10	330	2500	1500	270	2000	1500	200	1500	1500
Ø40-160	300	3500	-	250	3000	-	180	2500	-

FX-P650	Air gap < 0,2mm			Air gap 0,2 - 0,3 mm			Air gap 0,3 - 0,6 mm		
Material thickness (mm)	Max. Load (kg)	Max. L (mm)	Max. W (mm)	Max. Load (kg)	Max. L (mm)	Max. W (mm)	Max. Load (kg)	Max. L (mm)	Max. W (mm)
>= 4	160	2250	1500	130	2000	1500	110	2000	1500
>= 6	200	2500	1500	175	2250	1500	140	2250	1500
>= 8	450	3000	1500	400	3000	1500	320	2500	1500
>= 10	550	2500	1500	500	3000	1500	400	2500	1500
>= 20	650	3000	1500	570	3000	1500	450	2500	1500
Ø60-210	550	4000	-	480	3500	-	400	3000	-

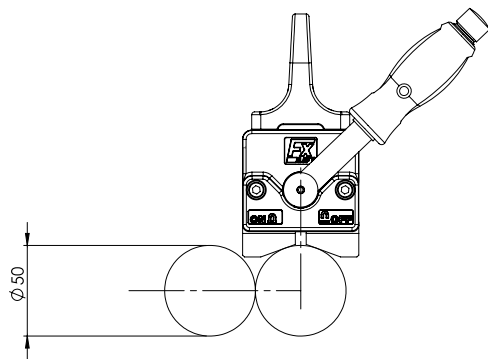

FX-P170

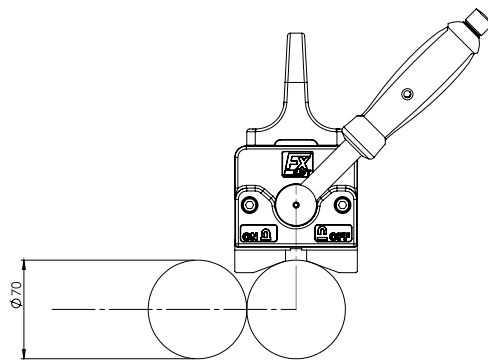

FX-P330

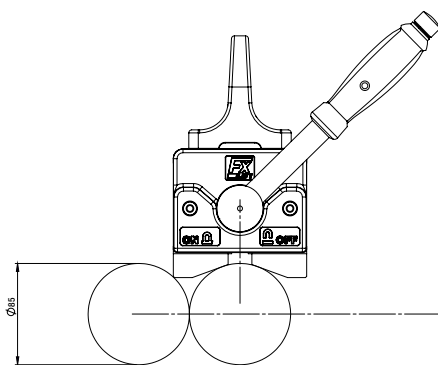

FX-P650

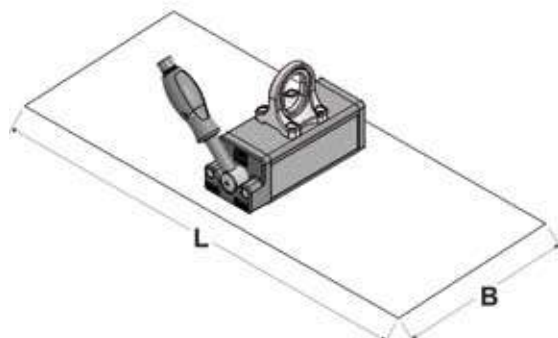

## FX-V Force / Load / Air Gap

FX-V200	Air gap < 0,1mm			Air gap 0,1 - 0,3 mm			Air gap 0,3 - 0,5 mm		
Material thickness (mm)	Max. Load (kg)	Max. L (mm)	Max. W (mm)	Max. Load (kg)	Max. L (mm)	Max. W (mm)	Max. Load (kg)	Max. L (mm)	Max. W (mm)
>= 4	70	1500	1250	50	1500	1250	35	1000	1250
>= 6	110	2000	1250	75	1500	1250	60	1250	1250
>= 8	175	2500	1250	120	2000	1250	90	2000	1250
>= 10	200	2500	1250	140	2000	1250	110	2000	1250
Ø20-50	100	2000	-	70	2000	-	60	1500	-
90°	120	2000	-	90	2000	-	60	1500	-

FX-V400	Air gap < 0,2mm			Air gap 0,2 - 0,3 mm			Air gap 0,3 - 0,6 mm		
Material thickness (mm)	Max. Load (kg)	Max. L (mm)	Max. W (mm)	Max. Load (kg)	Max. L (mm)	Max. W (mm)	Max. Load (kg)	Max. L (mm)	Max. W (mm)
>= 6	150	2000	1000	110	1500	1000	75	1250	1000
>= 8	280	2500	1250	210	2250	1250	150	2000	1250
>= 10	350	2500	1250	260	2250	1250	180	2000	1250
>= 15	400	2500	1250	290	2250	1250	220	2000	1250
Ø25-60	200	3500	-	160	2250	-	120	2500	-
90°	250	3500	-	190	3000	-	130	2500	-

FX-V800	Air gap < 0,2mm			Air gap 0,2 - 0,3 mm			Air gap 0,3 - 0,6 mm		
Material thickness (mm)	Max. Load (kg)	Max. L (mm)	Max. W (mm)	Max. Load (kg)	Max. L (mm)	Max. W (mm)	Max. Load (kg)	Max. L (mm)	Max. W (mm)
>= 4	130	2000	1500	100	2000	1500	90	2000	1500
>= 6	200	2500	1500	160	2250	1500	130	2250	1500
>= 8	400	3000	1500	320	3000	1500	270	2500	1500
>= 15	650	3000	1500	520	3000	1500	420	2500	1500
>= 20	800	3000	1500	650	3000	1500	550	2500	1500
Ø35-75	300	4000	-	240	3500	-	200	3000	-
90°	400	4000	-	320	3500	-	300	3000	-

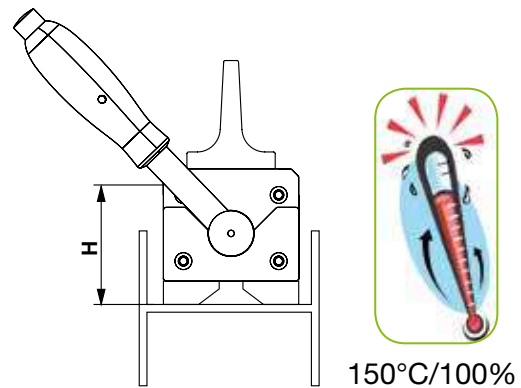
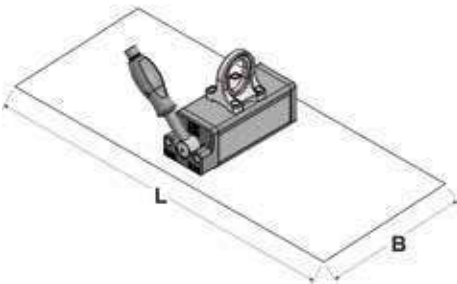

FX-V	H2 (mm)	IPE	HEB
FX-V 200	65	from IPE 80	from HEB 100
FX-V 400	87	from IPE 100	from HEB 120
FX-V 800	106	from IPE 140	from HEB 160



## PML Force / Load / Air Gap

PML 1	Air gap < 0,1mm			Air gap 0,1 - 0,3 mm			Air gap 0,3 - 0,5 mm			
	Material thickness (mm)	Max. Load capacity (kg)	Max. L (mm)	Max. A (dm <sup>2</sup> )	Max. Load capacity (kg)	Max. L (mm)	Max. A (dm <sup>2</sup> )	Max. Load capacity (kg)	Max. L (mm)	Max. A (dm <sup>2</sup> )
>= 2	15	800	60	12	800	50	9	800	40	
>= 4	35	1000	100	25	1000	70	20	1000	60	
>= 8	75	1000	100	65	1000	90	55	1000	75	
>= 12	100	1000	100	85	1000	85	70	1000	70	
Ø50-150	50	1500	-	40	1500	-	20	1500	-	

PML 6	Air gap < 0,1mm			Air gap 0,1 - 0,3 mm			Air gap 0,3 - 0,5 mm			
	Material thickness (mm)	Max. Load capacity (kg)	Max. L (mm)	Max. A (dm <sup>2</sup> )	Max. Load capacity (kg)	Max. L (mm)	Max. A (dm <sup>2</sup> )	Max. Load capacity (kg)	Max. L (mm)	Max. A (dm <sup>2</sup> )
>= 6	125	1800	260	110	1800	230	90	1600	190	
>= 10	330	2250	400	300	2250	360	270	2000	325	
>= 15	500	2500	410	450	2500	370	400	2250	330	
>= 20	600	3000	375	520	3000	325	500	2750	310	
Ø80-300	300	4000	-	250	3500	-	200	3000	-	

PML 20	Air gap < 0,1mm			Air gap 0,1 - 0,3 mm			Air gap 0,3 - 0,5 mm			
	Material thickness (mm)	Max. Load capacity (kg)	Max. L (mm)	Max. A (dm <sup>2</sup> )	Max. Load capacity (kg)	Max. L (mm)	Max. A (dm <sup>2</sup> )	Max. Load capacity (kg)	Max. L (mm)	Max. A (dm <sup>2</sup> )
>= 15	650	2500	540	600	2500	500	550	2250	460	
>= 20	1100	3000	680	1000	3000	620	900	2750	560	
>= 25	1350	3000	670	1200	3000	600	1000	2750	500	
>= 50	2000	4000	500	1780	4000	450	1470	3500	370	
Ø150-450	1000	4000	-	900	4000	-	800	4000	-	

PML 3	Air gap < 0,1mm			Air gap 0,1 - 0,3 mm			Air gap 0,3 - 0,5 mm			
	Material thickness (mm)	Max. Load capacity (kg)	Max. L (mm)	Max. A (dm <sup>2</sup> )	Max. Load capacity (kg)	Max. L (mm)	Max. A (dm <sup>2</sup> )	Max. Load capacity (kg)	Max. L (mm)	Max. A (dm <sup>2</sup> )
>= 4	60	1600	180	52	1600	160	45	1500	140	
>= 8	190	2000	290	160	2000	240	130	1800	195	
>= 10	220	2250	275	190	2250	230	150	2000	180	
>= 15	300	2500	250	270	2500	225	220	2250	185	
Ø60-300	150	3000	-	120	3000	-	80	2500	-	

PML 10	Air gap < 0,1mm			Air gap 0,1 - 0,3 mm			Air gap 0,3 - 0,5 mm			
	Material thickness (mm)	Max. Load capacity (kg)	Max. L (mm)	Max. A (dm <sup>2</sup> )	Max. Load capacity (kg)	Max. L (mm)	Max. A (dm <sup>2</sup> )	Max. Load capacity (kg)	Max. L (mm)	Max. A (dm <sup>2</sup> )
>= 8	230	2000	350	200	2000	300	170	1800	260	
>= 15	550	2500	450	500	2500	410	400	2250	330	
>= 20	825	3000	510	740	3000	450	620	2750	380	
>= 30	1000	3500	410	900	3500	370	750	3000	310	
Ø80-300	500	4000	-	400	4000	-	300	3500	-	

PML 30	Air gap < 0,1mm			Air gap 0,1 - 0,3 mm			Air gap 0,3 - 0,5 mm			
	Material thickness (mm)	Max. Load capacity (kg)	Max. L (mm)	Max. A (dm <sup>2</sup> )	Max. Load capacity (kg)	Max. L (mm)	Max. A (dm <sup>2</sup> )	Max. Load capacity (kg)	Max. L (mm)	Max. A (dm <sup>2</sup> )
>= 25	1400	3000	700	1300	3000	650	1050	2750	525	
>= 40	2000	3500	625	1920	3500	600	1500	3250	470	
>= 50	2500	4000	625	2400	4000	600	1850	3500	460	
>= 80	3000	5000	460	2880	5000	440	2400	4000	370	
Ø250-600	1250	4000	-	1000	4000	-	900	4000	-	

## PML-R Force / Load / Air Gap

PML-R1	Air gap < 0,1mm			Air gap 0,1 - 0,3 mm			Air gap 0,3 - 0,5 mm			
	Material thickness (mm)	Max. Load capacity (kg)	Max. L (mm)	Max. A (dm <sup>2</sup> )	Max. Load capacity (kg)	Max. L (mm)	Max. A (dm <sup>2</sup> )	Max. Load capacity (kg)	Max. L (mm)	Max. A (dm <sup>2</sup> )
>= 2	15	800	60	12	800	50	9	800	40	
>= 4	35	1000	100	25	1000	70	20	1000	60	
>= 8	75	1000	100	70	1000	90	65	1000	75	
>= 10	100	1000	100	85	1000	85	70	1000	70	
Ø40-150	60	1500	-	50	1500	-	40	1500	-	

PML-R3	Air gap < 0,1mm			Air gap 0,1 - 0,3 mm			Air gap 0,3 - 0,5 mm			
	Material thickness (mm)	Max. Load capacity (kg)	Max. L (mm)	Max. A (dm <sup>2</sup> )	Max. Load capacity (kg)	Max. L (mm)	Max. A (dm <sup>2</sup> )	Max. Load capacity (kg)	Max. L (mm)	Max. A (dm <sup>2</sup> )
>= 4	70	1600	210	52	1600	155	45	1500	135	
>= 6	125	2000	260	110	2000	230	100	1800	210	
>= 8	240	2250	375	220	2250	340	190	2000	290	
>= 10	300	2500	375	270	2500	340	210	2250	270	
Ø60-200	200	3000	-	180	3000	-	150	2500	-	

PML-R6	Air gap < 0,1mm			Air gap 0,1 - 0,3 mm			Air gap 0,3 - 0,5 mm			
	Material thickness (mm)	Max. Load capacity (kg)	Max. L (mm)	Max. A (dm <sup>2</sup> )	Max. Load capacity (kg)	Max. L (mm)	Max. A (dm <sup>2</sup> )	Max. Load capacity (kg)	Max. L (mm)	Max. A (dm <sup>2</sup> )
>= 6	130	2000	270	110	2000	230	90	1800	190	
>= 8	330	2500	510	310	2500	480	270	2250	420	
>= 10	425	2500	530	400	2500	500	340	2250	425	
>= 15	600	3000	500	550	3000	460	500	2750	420	
Ø60-200	400	4000	-	360	4000	-	300	3500	-	
Ø200-300	450	4000	-	405	4000	-	340	3500	-	

PML-R10	Air gap < 0,1mm			Air gap 0,1 - 0,3 mm			Air gap 0,3 - 0,5 mm			
	Material thickness (mm)	Max. Load capacity (kg)	Max. L (mm)	Max. A (dm <sup>2</sup> )	Max. Load capacity (kg)	Max. L (mm)	Max. A (dm <sup>2</sup> )	Max. Load capacity (kg)	Max. L (mm)	Max. A (dm <sup>2</sup> )
>= 10	440	2500	550	400	2500	500	340	2250	425	
>= 15	700	3000	580	630	3000	520	500	2750	420	
>= 20	900	3000	560	800	3000	500	630	2750	400	
>= 25	1000	3500	500	900	3500	450	750	3250	375	
Ø80-200	500	4000	-	450	4000	-	380	3500	-	
Ø200-360	750	4000	-	680	4000	-	560	3500	-	

PML-R20	Air gap < 0,1mm			Air gap 0,1 - 0,3 mm			Air gap 0,3 - 0,5 mm			
	Material thickness (mm)	Max. Load capacity (kg)	Max. L (mm)	Max. A (dm <sup>2</sup> )	Max. Load capacity (kg)	Max. L (mm)	Max. A (dm <sup>2</sup> )	Max. Load capacity (kg)	Max. L (mm)	Max. A (dm <sup>2</sup> )
>= 15	850	3000	700	760	3000	620	600	2750	490	
>= 20	1200	3000	750	1100	3000	680	840	2750	520	
>= 25	1350	3500	670	1200	3500	600	940	3250	470	
>= 50	2000	4000	500	1800	4000	450	1400	3750	350	
Ø100-200	1000	4000	-	900	4000	-	800	3500	-	
Ø200-460	1300	4000	-	1150	4000	-	1000	3500	-	

## FBM Battery Magnets Load Tables

Model	Load capacity for sheets and plates (St37)							
	Material thickness (mm)	surface finish				Irregular and rough surface air gap 0,3 - 0,5 mm	Very rough surface air gap > 0,5 mm	
		Clean and flat ground surface air gap < 0,1 mm	Rusty/warm rolled surface air gap 0,1 - 0,3 mm	Max. Dimensions LxW (mm)	Load capacity (kg)			Max. Dimensions LxW (mm)
FBM 13	38	2130 x 2130	1360	1900 x 1900	1160	1700 x 1700	900	Ask your Supplier
	25	2130 x 2130	950	1830 x 1830	890	1830 x 1520	770	
	19	2130 x 2130	660	1830 x 1830	580	1830 x 1520	500	
	13	2130 x 2130	370	1830 x 1830	340	1520 x 1520	290	
	10	1830 x 1520	180	1520 x 1520	160	1520 x 1520	150	
	6	1220 x 1220	90	1220 x 1220	86	1220 x 1220	80	
FBM 25	50	2400 x 2400	2500	2400 x 2100	2100	2100 x 2100	1750	
	38	2400 x 2400	1850	2400 x 2100	1620	2100 x 2100	1350	
	25	2400 x 2400	1200	2400 x 2100	1130	2100 x 2100	950	
	19	2400 x 2400	800	2100 x 2100	700	2100 x 1800	610	
	13	1800 x 1800	370	1800 x 1800	360	1800 x 1800	330	
	10	1800 x 1500	250	1800 x 1500	200	1800 x 1500	180	
FBM 36	6	1500 x 1200	110	1500 x 1200	100	1500 x 1200	90	
	25	6000 x 3000	3600	6000 x 2700	3270	4300 x 3000	2730	
	19	6600 x 2400	2430	6000 x 2400	2230	4500 x 2400	1960	
	13	5100 x 2400	1250	4800 x 2400	1180	4500 x 2400	1090	
	10	3900 x 2400	720	3600 x 2400	660	3300 x 2400	610	
	6	3600 x 1800	340	3300 x 1800	300	3300 x 1500	270	
FBM 50	3	2400 x 1800	110	2100 x 1800	100	1800 x 1800	90	
	50	3600 x 3300	5000	3300 x 3000	4200	3000 x 2700	3500	
	38	3300 x 3300	3700	3300 x 3300	3240	3000 x 2700	2700	
	25	3300 x 3300	2400	3300 x 3000	2260	3000 x 2700	1900	
	19	3000 x 2700	1600	3000 x 2700	1400	2700 x 2700	1220	
	13	2700 x 2400	740	2700 x 2400	720	2400 x 2400	660	
FBM-P 18	10	2100 x 2100	500	2100 x 2100	400	2100 x 2100	360	
	6	1800 x 1800	220	1800 x 1800	200	1800 x 1800	180	
	50	2000 x 2000	1800	1700 x 1500	1030	1500 x 1500	930	
	38	1900 x 1900	1130	1800 x 1500	930	1800 x 1500	850	
	25	2100 x 2100	1020	2100 x 1800	840	2100 x 1800	760	
	19	2400 x 2100	800	2100 x 1800	660	2100 x 1800	590	
FBM-P 36	13	2400 x 2100	570	2100 x 2100	470	2100 x 1800	420	
	10	2100 x 2100	390	2100 x 1800	310	2100 x 1500	270	
	6	2000 x 2000	250	2000 x 1500	200	1800 x 1500	150	
	70	-	3600	-	3400	-	3200	
	40	2700 x 2700	2275	2400 x 2400	2440	2400 x 2100	2320	
	30	3000 x 3000	1730	2700 x 2700	1570	2700 x 2400	1420	

Model	Load capacity for I-Profiles, rods and pipes (St37)								
	Web thickness (mm)	I-Profile		Rods			pipes (thick-walled)		
		Max. Length (mm)	Load capacity (kg)	Ø (mm)	Max. Length (mm)	Load capacity (kg)	Ø (mm)	Max. Length (mm)	Load capacity (kg)
FBM-P 18	25	6000	840	25 - 300	6000	1130	25 - 300	6000	1130
	20	6000	680	150 - 300	6000	1130			
	10	6000	310						
	6	6000	200						
FBM-P 36	25	6000	1500	25 - 150	6000	2260	25 - 300	6000	2260
	20	6000	1250	150 - 300	6000	2260			
	10	6000	600						
	6	6000	370						

## Examination of Lifting Magnets

New Lifting Magnets are delivered by us with a manufacturer's declaration of conformity, which confirms compliance with the standards MD 2006/42 EC and EN 13155. As in the EN 13155 testing of lifting magnets is regulated, at delivery must be accompanied by no separate audit log.

An exceptional check shall be carried out to repair or extraordinary incidents (crash, collision) DGUV/BGR 500/Chapter 2.8.

A regular check shall be conducted at least annually according to DGUV/BGR 500/Section 2.8.

Depending on the conditions of the load receiving means tests at shorter intervals may be necessary.

We will gladly check your Lifting magnets at our factory or at your site.

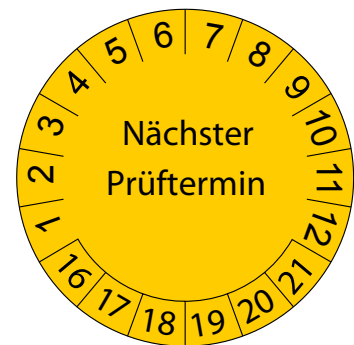

Our mobile testing service for lifting magnets checks all brands locally.

The mobile Check-device can be brought directly to the workstation of the user, so that the test can be carried out without losing too much time.

Spare parts for nearly all of the outstanding lifting magnets leads our auditors with him, so that even in case of defects the device is available again after a short time.

For long-term testing of these services at very low travel expenses is available.

We will gladly advise you on retests DGUV/BGR 500.

## MAGNETIC CLAMPING

Magnetic clamping devices such as magnetic chucks, rotary chucks and blocks are used in all sectors of metalworking. When grinding, milling, eroding and in metrology, magnetic clamping devices have proven daily by high precision, distortion-free clamping and durability. In the following overview you will find a wide range of magnetic clamping devices for different applications. In addition to our wide range of standard equipment, we also offer special solutions for your individual clamping problem.

The holding forces indicated in Chapter „Magnetic clamping“ refer to a test work with 40x40x20mm and sanded surface of St37.

The following factors reduce the holding force:

- Poor surface (air gap)
- Poorly magnetizable materials such as cast iron or alloy steel
- Full-surface occupancy of the magnetic disk (the total holding force increases, the holding force however drops per cm<sup>2</sup>)

For more information, see „Selection guide for lifting magnets and air gap tables“, on page 60



**Page 69 - 73**

Permanent Magnetic Chucks



**Page 74 - 77**

Sine tables with Magnetic Chucks



**Page 78 - 83**

Electro Magnetic Chucks



**Page 84 - 100**

Electro-Permanent Magnetic Systems and Supplies



**Page 101 - 112**

Palettized Magnetic Chucks, Handling Systems



**Page 113 - 121**

Magnetic circular Chucks Permanent and Electro-Permanent



**Page 122 - 123**

Lamella plates and -Blocks



**Page 124 - 130**

Magnetic clamping Blocks, -Prisms and -Blocks

## PMNM Permanent Magnetic Chucks

Permanent magnetic chucks type PMNM are high precision plates for clamping small and thin parts for precision grinding and eroding. The low magnetic field height prevents magnetization of the processing tools. The chipboard is activated via a removable hex shifter.

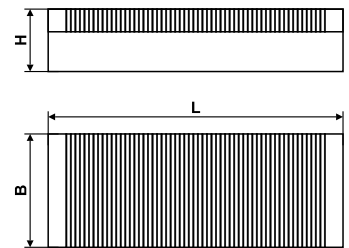
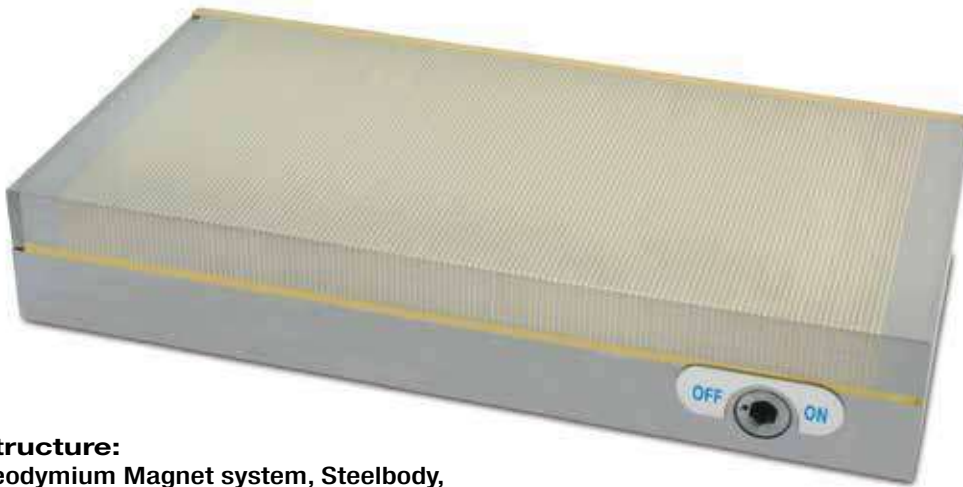

### Structure:

Neodymium Magnet system, Steelbody,  
Transverse pole pitch 1.4 + 0.5 mm  
Holding power ca. 100 N/cm<sup>2</sup>  
Magnetic field Height ca. 5 mm  
Poleplate wearing limit 6 mm

### Recommendation:

High-precision drive for grinding and eroding

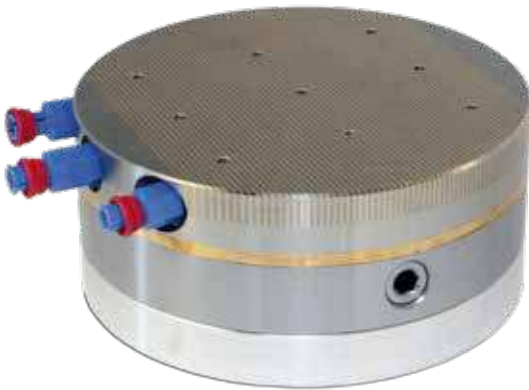

Option Flushing hole for EDM



3D Machining the clamping surface

Model	Article-Nr.	Dimensions (mm)			Weight (kg)
		L	B	H	
PMNM 1007	2004 1007	100	70	48	3
PMNM 1210	2004 1210	120	100	48	5
PMNM 1470	2004 1470	140	70	48	7
PMNM 1710	2004 1710	175	100	48	7
PMNM 2010	2004 2010	200	100	48	8
PMNM 2011	2004 2011	200	110	48	9
PMNM 2012	2004 2012	200	120	48	10
PMNM 2510	2004 2510	250	100	48	10
PMNM 2513	2004 2513	255	130	48	13
PMNM 1510	2004 1510	100	150	48	6
PMNM 1515*	2004 1515	150	150	51	9
PMNM 2515	2004 2515	250	150	51	16
PMNM 3015	2004 3015	300	150	51	19
PMNM 3515	2004 3515	350	150	51	22
PMNM 4015	2004 4015	400	150	51	25
PMNM 4515	2004 4515	450	150	51	28
PMNM 4520	2004 4520	450	200	51	42
PMNM 3020	2004 2030	300	200	51	18
PMNM 4020	2004 4020	400	200	51	33
PMNM 5020	2004 5020	500	200	51	41
PMNM 5025	2004 5025	500	250	51	61
PMNM 6020	2004 6020	600	200	51	49
PMNM 2424*	2019 2424	240	240	40	18
PMNM 3525	2004 3525	350	250	51	36
PMNM 4030	2004 4030	400	300	51	49
PMNM 5030	2004 5030	500	300	56	67
PMNM 6030	2004 6030	600	300	56	81
PMNM 6040	2004 6040	600	400	56	81

Other dimensions on request

All PMNM magnetic clamping plates can be incorporated a flushing drilling in the pole plate!

\* Magnetic chucks especially suited for palletizing

Look at Page 103.

## PMNM-W Permanent Magnetic Chucks

PMNM-W permanent magnet chucks have the same magnetic properties as the proven PMNM and may be used by construction, both with the horizontal and vertical magnetic clamping surface. PMNM-W are suitable for grinding edges of plates for angle-grinding of blocks and wire EDM. In use, the PMNM-W is simply clamped in the rule to the electromagnet plate the surface grinder.

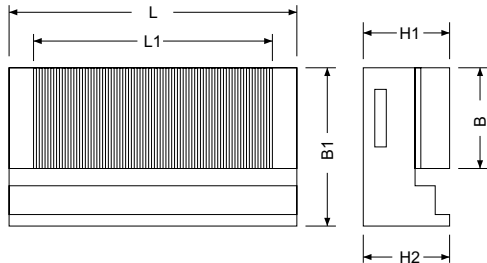

Model	Item-Nr.	Dimensions (mm)				Magnetic active L1 x W (mm)	Weight (kg)
		L	H2	H1	W1		
PMNM-W 1710	2024 1710	180	65	67	140	140 x 100	11
PMNM-W 2515	2024 2515	255	65	67	190	206 x 150	22
PMNM-W 3515	2024 3515	355	65	67	190	305 x 150	31
PMNM-W 4020	2024 4020	405	68	70	240	357 x 200	47

Other dimensions on request  
All PMNM magnetic clamping plates can be incorporated a flushing drilling in the pole plate!

**Structure:**  
Neodymium Magnet system,  
Steel body,  
Transverse pole pitch 1.4+0.5mm  
Holding power ca. 100 N/cm<sup>2</sup>  
Magnetic field Height ca. 5 mm  
Pole plate wearing limit 6 mm

**Recommendation:**  
High-precision drive for grinding  
and eroding

## PMSF Permanent Magnetic Chucks

Permanent magnetic chucks type PMSF are designed for eroding and grinding of fine parts. With very low profile and low weight they can also be well used to exchange pallets. The low magnetic field height prevents magnetization of processing tools. The chipboard is activated via a removable hex shifter.

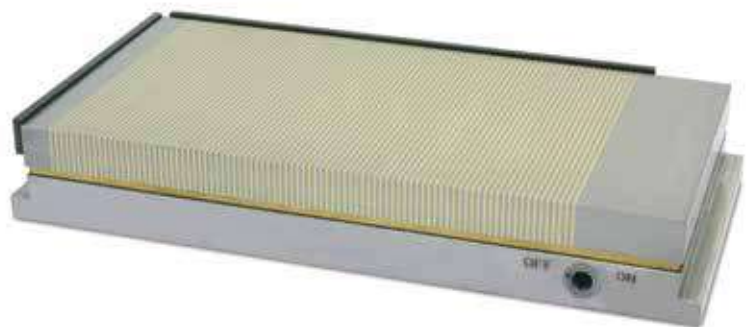
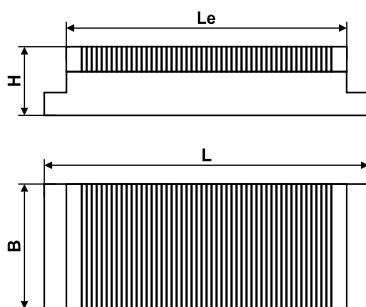

Model	Item-Nr.	Dimensions (mm)				Weight (kg)
		L	B	H	Le	
PMSF 1510	2003 1510	165	100	40	150	5
PMSF 2010	2003 2010	215	100	40	200	6
PMSF 2513	2003 2513	270	130	40	255	11
PMSF 1515	2003 1515	165	150	40	150	7
PMSF 2515	2003 2515	265	150	40	250	12
PMSF 3015	2003 3015	315	150	40	300	14
PMSF 3515	2003 3515	365	150	40	350	17
PMSF 4015	2003 4015	415	150	40	400	19
PMSF 4515	2003 4515	465	150	40	450	22

Other dimensions on request!

**Structure:**  
Neodymium Magnet system, Steel body,  
Transverse pole pitch 1.5 + 0.8 mm  
Holding power ca. 80 N/cm<sup>2</sup>  
Magnetic field Height ca. 6 mm  
Pole plate wearing limit 5 mm

**Recommendation:**  
Economical plate for precise grinding and  
eroding

## PMNS Permanent Magnetic Chucks

Permanent magnetic chucks type PMNS are a special type of high-precision PMNM. The switching point is located above and the overall height is reduced to a minimum of 35mm. They are used where a flat and lightweight design is important and you cannot turn the side of space or handling reasons. The overhead Allen-shifting is protected by a removable pin to contamination. The low magnetic field height prevents magnetization of processing tools. The chipboard is activated via a removable hex shifter.



### Structure:

Neodymium Magnet system, Steel body,  
 Transversal pole pitch 1.4 + 0.5 mm  
 Holding power ca. 100 N/cm<sup>2</sup>  
 Magnetic field Height ca. 5 mm  
 Pole plate wearing limit 6 mm

### Recommendation:

High-precision, super-flat plate for grinding  
 and eroding

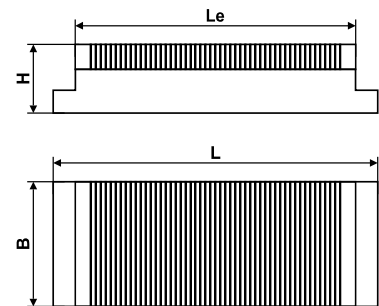

Model	Item-Nr.	Dimensions (mm)				Weight (kg)
		L	B	H	Le	
PMNS 1515	2005 1515	150	150	35	95	7
PMNS 1710	2005 1710	170	100	35	120	6
PMNS 2513	2005 2513	250	130	35	200	10,5
PMNS 2515	2005 2515	250	150	35	195	13
PMNS 3015	2005 3015	300	150	35	245	15
PMNS 3515	2005 3515	350	150	35	295	17,5
PMNS 4020	2005 4020	400	200	35	345	27,5
PMNS 4515	2005 4515	450	150	35	395	21,5

All PMNM magnetic clamping plates can be incorporated a flushing drilling in the pole plate!

## PMNEO Permanent Magnetic Chucks

Permanent magnetic chucks type PMNEO are super strong compact chucks for heavy cutting. Parts from about 30x15x6mm are stretched with max. achievable holding forces. Good holding forces can be achieved even on rough surfaces. The chipboard is activated via a removable hex shifter.



### Structure:

Double Neodymium Magnet system,  
Steel body,  
Transversal pole pitch 11 + 4 mm  
Holding power ca. 150 N/cm<sup>2</sup>  
Magnetic field Height ca. 10 mm  
Pole plate wearing limit 6 mm

### Recommendation:

Super strong plate for milling

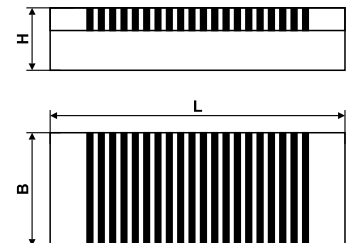

Special Version with threaded bushings in Magnetic poles and built-on Pole-boards.

Model	Item-Nr.	Dimensions (mm)			Weight (kg)
		L	B	H	
PMNEO 2515	2007 2515	250	150	56	17
PMNEO 3015	2007 3015	300	150	56	18
PMNEO 3515	2007 3515	350	150	56	24
PMNEO 4515	2007 4515	450	150	56	31
PMNEO 3020	2007 3020	300	200	56	26
PMNEO 4020	2007 4020	400	200	56	35
PMNEO 5020	2007 5020	500	200	56	44
PMNEO 6020	2007 6020	600	200	56	52
PMNEO 2424*	2007 2424	240	240	48	21
PMNEO 4025	2007 4025	400	250	56	38
PMNEO 5025	2007 5025	500	250	56	65
PMNEO 6025	2007 6025	600	250	56	64
PMNEO 2828*	2007 2828	280	280	48	28
PMNEO 5030	2007 5030	500	300	56	56
PMNEO 6030	2007 6030	600	300	56	78
PMNEO 3232*	2007 3233	320	320	48	35
PMNEO 4040*	2007 4040-1	400	400	48	57

Other dimensions on request

\* Magnetic chucks especially suited for palletizing  
Look at Page 103



## PMNM INOX Permanent Magnetic Chucks

PMNM INOX Magnetic plates are made of corrosion-resistant stainless steel and are used for machining under aggressive atmospheres or in aggressive media. The fine pole pitch and the flat magnetic field ensure that no magnetic stripes interfere with the machining processes.



Model	Item-Nr.	Dimensions (mm)			Weight (kg)
		L	B	H	
PMNM INOX 1515	2008 1515	150	150	40	9
PMNM INOX 3015	2008 3015	300	150	40	19
PMNM INOX 2424	2008 2424	240	240	40	18
PMNM INOX 2828	2008 2828	280	280	40	33

Other dimensions on request!

### Structure:

Neodym Magnetic System, VA Body,  
 Transversal pole pitch 1.4 + 0.5 mm  
 Holding power ca. 60 N/cm<sup>2</sup>  
 Magnetic filed Height ca. 5 mm  
 Pole plate wearing limit 3 mm

### Recommendation:

Stainless clamping plate for use in an aggressive environment.

## PM-SMCO Permanent Magnetic Chucks

The PM-SMCO high-temperature magnetic chuck can be used permanently at 250°C. It is also possible to equip the magnetic clamping plate with heating elements so that an active heating of the stretched material is possible. PM-SMCO magnetic chucks are used to fix vulcanization, thermal bonding tools or sand core molds in machines or devices. Size and design are customized as needed.



max. 250°C



### SINE TABLES

Sine tables are used to edit angle surfaces on diverse workpieces precisely. Using gauge blocks any angle can be set according the sine principle. Sine tables are mainly used in tool and fixture, often where an angular precision of 5 seconds is required.



We offer a wide range of standard equipment and also gladly be produced according to your specifications, in precision of 5 seconds with permanent or electro-permanent magnetic chucks for grinding, milling, and EDM wire cutting.

### NMS Sine tables

NMS Precision Sine Tables with built PMNM chipboard impress with very good workmanship and precision. The sine table base is hardened to 60 HRC, burnished and precision ground. The angle is adjusted according the sine principle by using gauge blocks. Our NMS sine tables are used in the EDM, grinding and measuring in the highest precision.

#### Technical Details:

Precision Sine Table with built fine pole chipboard

Holding power ca. 100 N/cm<sup>2</sup>

Magnetic field Height ca. 5 mm

Pole plate wearing limit 5 mm

Plane parallelism 0,005/100mm

Angle accuracy  $\pm 0,0013^\circ / \pm 5$  sec.

## NMSI Sine tables

NMSI Precision Sine Table Swivel on the longitudinal axis to an angle of max. 45°.

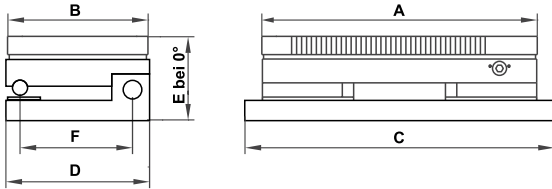

Model	Item-Nr.	Dimensions (mm)						Weight (kg)
		A	B	C	D	E	F	
NMSI 1710	2011 1710	175	100	215	115	76	85	10
NMSI 2513	2011 2513	255	130	295	145	76	115	20
NMSI 2515	2011 2515	250	150	290	165	79	135	21,5
NMSI 3015	2011 3015	300	150	340	165	79	135	27
NMSI 3515	2011 3515	350	150	390	165	87	135	34,5
NMSI 4515	2011 4515	450	150	490	165	87	135	44
NMSI 3020	2011 3020	300	200	340	215	81	185	35
NMSI 4020	2011 4020	400	200	440	215	88	185	52
NMSI 6020	2011 6020	600	200	640	215	83	185	78
NMSI 6030	2011 6030	600	300	660	320	88	285	121

## NMSIL Sine tables

NMSIL Precision Sine Table Swivel on the transverse axis to an angle of 30°.

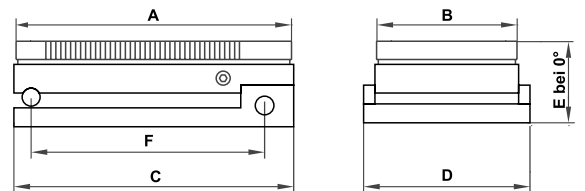

Model	Item-Nr.	Dimensions (mm)						Weight (kg)
		A	B	C	D	E	F	
NMSIL 1710	2014 1710	175	100	190	140	76	160	10
NMSIL 2513	2014 2513	255	130	270	170	76	240	21
NMSIL 3015	2014 3015	300	150	315	190	76	285	27
NMSIL 4515	2014 4515	450	150	465	190	88	435	46
NMSIL 4020	2014 4020	400	200	415	240	88	385	53,5
NMSIL 5020	2014 5020	500	200	515	240	88	485	99
NMSIL 6020	2014 6020	600	200	615	240	88	585	108
NMSIL 6030	2014 6030	600	300	615	340	88	585	125

## NMSID Sine tables

NMSID precision sine tables pivot about the longitudinal axis up to 45° and about the transverse axis to an angle of 30°.

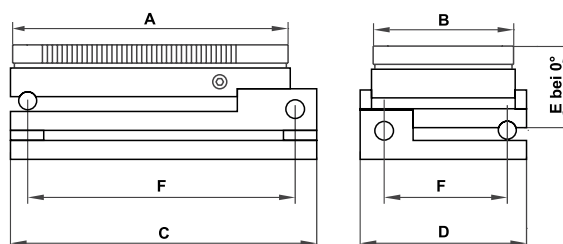

Model	Item-Nr.	Dimensions (mm)						Weight (kg)
		A	B	C	D	E	F	
NMSID 1710	2012 1710	175	100	210	140	104	165/110	15
NMSID 2513	2012 2513	255	130	290	170	120	245/140	32
NMSID 3015	2012 3015	300	150	335	190	123	290/160	43,5
NMSID 3515	2012 3515	350	150	385	190	123	340/160	49,5
NMSID 4515	2012 4515	450	150	485	190	124	440/160	52
NMSID 4020	2012 4020	400	200	435	240	124	390/210	73
NMSID 5020	2012 5020	500	200	535	240	126	490/210	84
NMSID 6020	2012 6020	600	200	635	240	126	590/210	102
NMSID 6030	2012 6030	600	300	635	340	128	590/310	148

## NMSM Sine tables

NMSM Sine Table Swivel on the central axis by  $\pm 90^\circ$ .

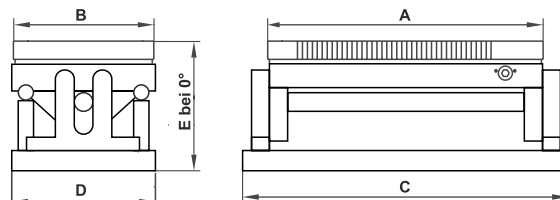

Model	Item-Nr.	Dimensions (mm)					Weight (kg)
		A	B	C	D	E	
NMSM 2515	2017 2515	250	150	300	160	85	29
NMSM 3515	2017 3515	350	150	400	160	96	38
NMSM 4020	2017 4020	400	200	450	210	104	58

## SFS Sine tables

SFS sine tables with built PMSF chipboard impress with good workmanship and compact design. The main body is hardened to approximately 50 HRC. The angle is adjusted according the sine principle by using gauge blocks. Fixation is achieved by the side-mounted attachment scissors. Our economical SFS sine tables in good precision are used in grinding, measuring and eroding.

### Technical Details:

Single axis sine table with built fine pole chipboard, Holding power ca. 80 N/cm<sup>2</sup>,  
Magnetic field Height ca. 6 mm, Pole plate wearing limit 5 mm,  
Plane parallelism 0,002/100 mm, Angle accuracy  $\pm 0,0027^\circ$  /  $\pm 10$  sec.

## SFSI Sine tables

SFSI Sine Table Swivel on the longitudinal axis to an angle of max. 45°.

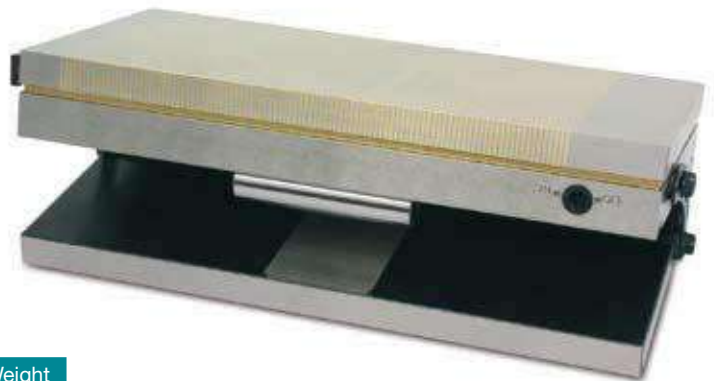
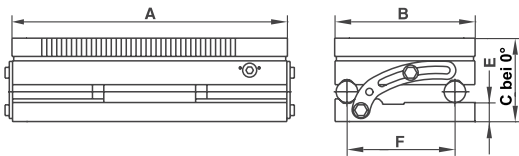

Model	Item-Nr.	Dimensions (mm)					Weight (kg)
		A	B	C	E	F	
SFSI 1510	2009 1510	150	100	77	17	75	7
SFSI 2010	2009 2010	200	100	77	17	75	10
SFSI 2513	2009 2513	255	130	77	17	100	16
SFSI 1515	2009 1515	150	150	77	17	125	11
SFSI 2515	2009 2515	250	150	77	17	125	18
SFSI 3015	2009 3015	300	150	77	17	125	22
SFSI 3515	2009 3515	350	150	77	17	125	26

Hardened Precision stop strips on request

## SFSID Sine tables

SFSID Sine Table Swivel on the longitudinal and transverse axis to an angle of 45°.

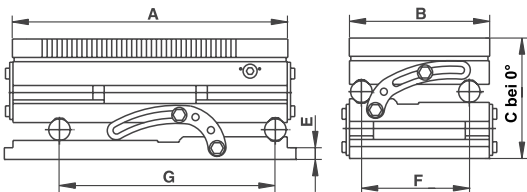

Model	Item-Nr.	Dimensions (mm)						Weight (kg)
		A	B	C	E	F	G	
SFSI 1510	2010 1510	150	100	114	17	75	125	9
SFSI 2010	2010 2010	200	100	114	17	75	175	13
SFSI 2513	2010 2513	255	130	114	17	100	200	21
SFSI 1515	2010 1515	150	150	114	17	125	125	14
SFSI 2515	2010 2515	250	150	114	17	125	200	23
SFSI 3015	2010 3015	300	150	114	17	125	250	29

Hardened Precision stop strips on request

## EF Electro Magnetic Chucks

EF electric magnetic chucks are available in small to medium sizes. They have a very fine pole pitch. Their use is particularly recommended for clamping small, thin parts from approximately 7x5x2mm on surface grinders. By using modern pole-reversal devices the adhesive force can be regulated and the workpiece can be demagnetized after machining. EF magnetic chucks convincing uniform holding force over the entire gripping range, very high stiffness by mono-block design and minimal warming - even with long turn-on times.

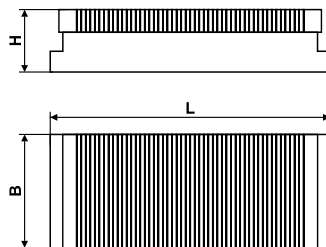
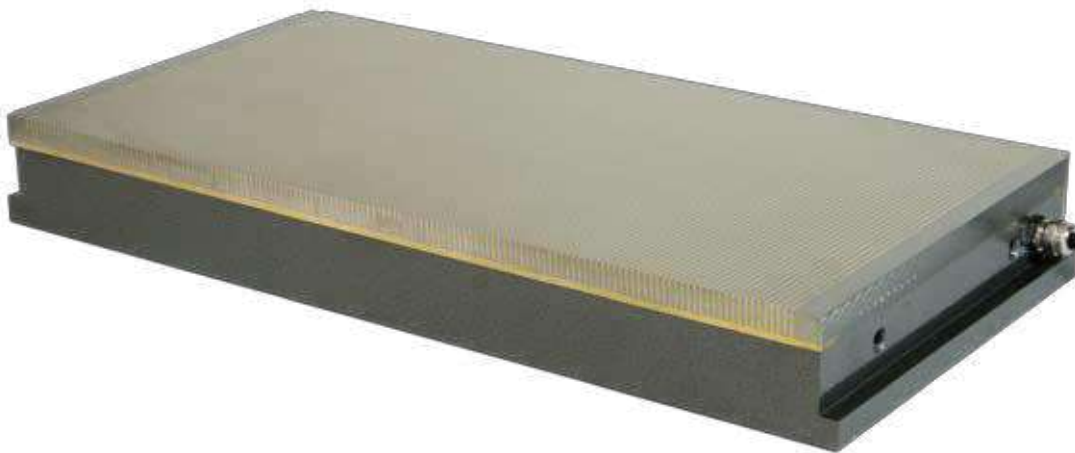

Model	Item-Nr.	Dimensions (mm)			Performance (Watt)	Weight (kg)
		L	B	H		
EF 2515	2201 02515	250	150	75	71	17
EF 3015	2201 03015	300	150	75	78	20
EF 3515	2201 03515	350	150	75	73	23
EF 4015	2201 04015	400	150	75	96	27
EF 4515	2201 04515	450	150	75	91	30
EF 4020	2201 04020	400	200	75	113	35
EF 4520	2201 04520	450	200	75	108	38
EF 5020	2201 05020	500	200	75	166	43
EF 6020	2201 06020	600	200	75	143	53
EF 6025	2201 06025	600	250	75	190	67
EF 6030	2201 06030	600	300	75	280	80
EF 8030	2201 08030	800	300	75	304	107
EF 10030	2201 10030	1000	300	75	380	133
EF 6040	2201 06040	600	400	75	304	107
EF 8040	2201 08040	800	400	75	405	142
EF 10050	2201 10040	1000	400	75	506	178
EF 8050	2201 08050	800	500	75	506	178
EF 10050	2201 10050	1000	500	75	633	223

Other dimensions on request!

### Structure:

Electro Magnet system,  
Steel body + Pole,  
Transverse or longitudinal pole pitch 1+3mm  
Holding power ca. 100 N/cm<sup>2</sup>  
Magnetic field Height ca. 6 mm  
Pole plate wearing limit 7 mm  
Voltage 110 VDC  
Protection IP 67

### Recommendation:

Precise electric magnetic chuck for grinding small, thin workpieces.

The standard package includes 3m connection cable and a long and a short side stop bar. Matching pole-reversal devices type USG are also available on Page 80

## UG Electro Magnetic Chucks

UG electro-magnetic chucks are available in medium and large sizes. They have a universal 19mm pole pitch with intermediate steps. They are universal and will hold workpieces from about 20x10x5mm safe. UG magnetic chucks convincing uniform holding force over the entire gripping range, very high stiffness by mono-block design and minimal warming, even with long turn-on times.

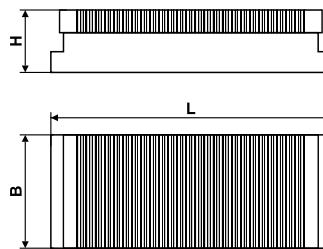
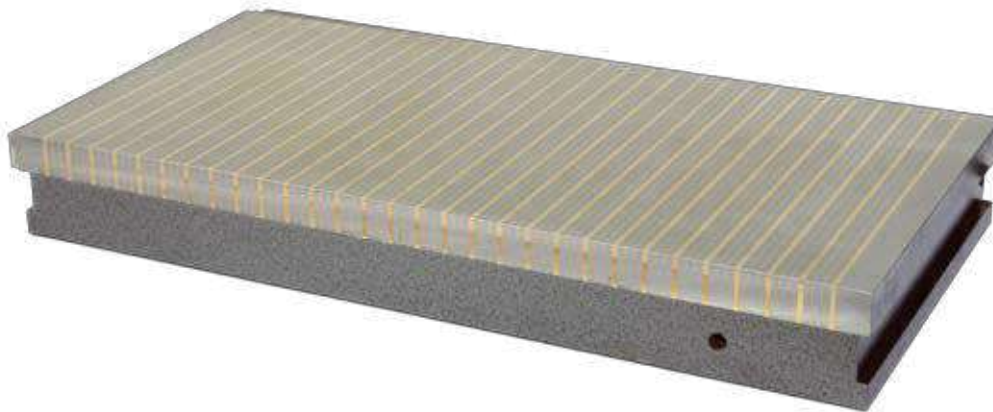

### Structure:

Electro Magnet system,  
Steel body + Pole,  
Transverse or longitudinal pole pitch  
5+0.5+5+0.5+5+3 mm  
Holding power ca. 100 N/cm<sup>2</sup>  
Magnetic field Height ca. 8 mm  
Pole plate wearing limit 7 mm  
Voltage 110 VDC  
Protection IP 67

### Recommendation:

Universal electric magnetic chuck for grinding.

The standard package includes 3m connection cable and a long and a short side stop bar. Matching pole-reversal devices type USG are also available on Page 80

Model	Item-Nr.	Dimensions (mm)			Performance (Watt)	Weight (kg)
		L	B	H		
UG 6020	2202 06020	600	200	73	85	75
UG 6025	2202 06025	600	250	73	106	94
UG 6030	2202 06030	600	300	73	130	108
UG 8030	2202 08030	800	300	73	150	144
UG 9030	2202 09030	900	300	73	210	162
UG 10030	2202 10030	1000	300	73	235	180
UG 12030	2202 12030	1200	300	73	248	216
UG 15030	2202 15030	1500	300	83	283	300
UG 6040	2202 06040	600	400	73	200	122
UG 7040	2202 07040	700	400	73	258	142
UG 7540	2202 07540	750	400	73	240	153
UG 8040	2202 08040	800	400	73	226	163
UG 9040	2202 09040	900	400	73	310	183
UG 10040	2202 10040	1000	400	73	280	203
UG 12040	2202 12040	1200	400	73	404	270
UG 15040	2202 15040	1500	400	83	428	337
UG 20040	2202 20040	2000	400	83	520	449
UG 6050	2202 06050	600	500	73	233	157
UG 10050	2202 10050	1000	500	73	330	348
UG 12050	2202 12050	1200	500	73	469	348
UG 15050	2202 15050	1500	500	83	552	434
UG 12060	2202 12060	1200	600	73	430	430
UG 15060	2202 15060	1500	600	83	540	538
UG 20060	2202 20060	2000	600	83	607	717
UG 10080	2202 10080	1000	800	73	490	433
UG 20080	2202 20080	2000	800	83	980	866

Other dimensions on request!

## USG-TG Pole Reversal Devices

Electric magnetic chucks are operated on pole-reversal device. These devices make it possible to regulate the adhesive force and to demagnetize workpieces. Pole-reversal devices can be supplied as a switch cabinet or table. It is to pay attention to the voltage and power of the magnet. USG - TG pole-reversal devices desktop version are optimal for the subsequent development of electric - magnetic chucks combined with easy installation. The device is simply plugged into 230V mains voltage, power cord with plug and manual control unit are included.



Model	Item-Nr.	Performance (Watt)	Dimensions (mm)			Weight (kg)	<b>Technical Data:</b> Voltage 230V /50 HZ Output-voltage 0-110 V DC Body IP 44 / Safety class 1 100% ED ,0-40 ° C Enable contact for machine safety services to1,5 KW Hand panel 100x115x40mm Cable length 5m to the control unit can be plugged
			L	B	H		
USG-TG 125	9040 0125	125	330	180	140	6	
USG-TG 250	9040 0250	250	330	180	140	9	
USG-TG 400	9040 0400	400	330	180	140	11	
USG-IP54/750	9040 0750	750	300	300	120	12	
USG-EB 750	9040 0751	750	240	160	105	8	
USG-IP54/1500	9040 1500	1500	300	300	120	10	
USG-EB 1500	9040 1501	1500	240	160	105	12	

All reversing control units are available with additional Hand panel

USG pole-reversal devices are mostly used for magnetic clamping plates on surface grinding machines, but can also be used in automation technology to control lifting magnets or gripper plates. When used for lifting magnets and grab a feedback contact is often required not only the switching states „Clamped“ and „Solved“ displays but also the switching status „degauss runs“. For this, the auxiliary control board USG - SP must also be ordered.



## EFP Electro-Permanent Magnetic Chucks

EFP electro-permanent magnetic clamping plates with a fine pole division combine the advantages of permanent and electro-magnetic chucks. The particle board does not heat up during long chip times, has a very controlled magnetic field and offers the possibility of holding force control and demagnetization. EFP magnetic chucks designed for grinding and eroding the highest precision even on small workpieces. They impress with uniform holding force over the entire gripping range.

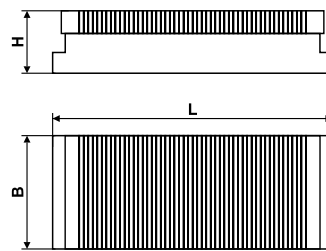
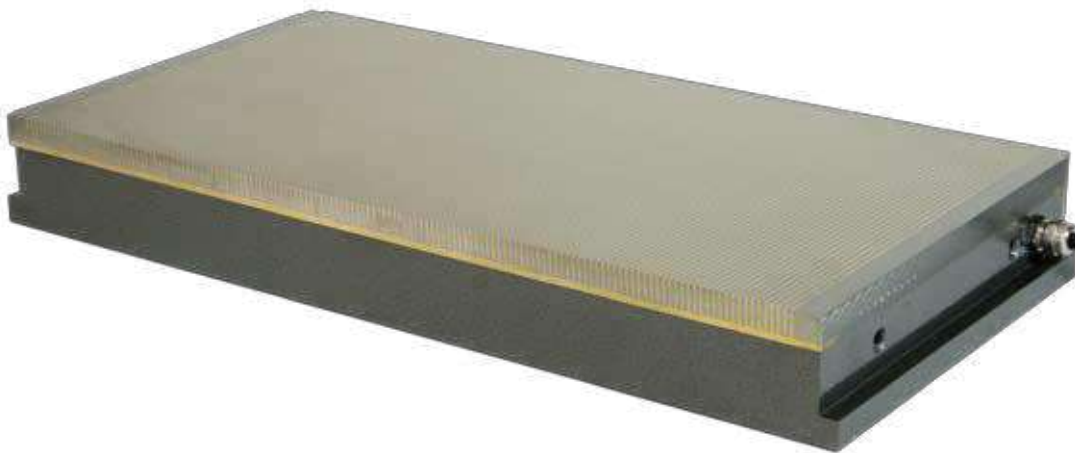

### Structure:

Electro-Permanent Magnet system  
 Steel body + Pole,  
 Transverse or longitudinal pole pitch 1+3mm  
 Holding power ca. 100 N/cm<sup>2</sup>  
 Magnetic field Height ca. 4 mm  
 Pole plate wearing limit 7 mm  
 Performance 210 V Impulse  
 Protection IP 67

### Recommendation:

High-precision electro-permanent chipboard for grinding small, thin workpieces.

Model	Item-Nr.	Dimensions (mm)			Weight (kg)
		L	B	H	
EFP 4020	2701 04020	400	200	75	35
EFP 4520	2701 04520	450	200	75	38
EFP 5020	2701 05020	500	200	75	43
EFP 6020	2701 06020	600	200	75	53
EFP 6025	2701 06025	600	250	75	67
EFP 6030	2701 06030	600	300	75	80
EFP 8030	2701 08030	800	300	75	107
EFP 10030	2701 10030	1000	300	75	133
EFP 6040	2701 06040	600	400	75	107
EFP 8040	2701 08040	800	400	75	142
EFP 10040	2701 10040	1000	400	75	178
EFP 8050	2701 08050	800	500	75	178
EFP 10050	2701 10050	1000	500	75	223
Other dimensions on request!					

The standard package includes 3m connection cable and a long and a short side stop bar. Matching pole-reversal devices type ST 211 GR are also available on Page 99-100

TIP: EFP magnetic clamping plates can be used on most built-in Pole-reversal devices in European grinders.

## UGP Electro-Permanent Magnetic Chucks

UGP electro-permanent magnetic clamping plates with 15+3mm parallel pole pitch suitable to clamp workpieces from 40x40x10mm safely and accurately. The electro-permanent magnet system does not heat up during long chip times and has a very controlled magnetic field.

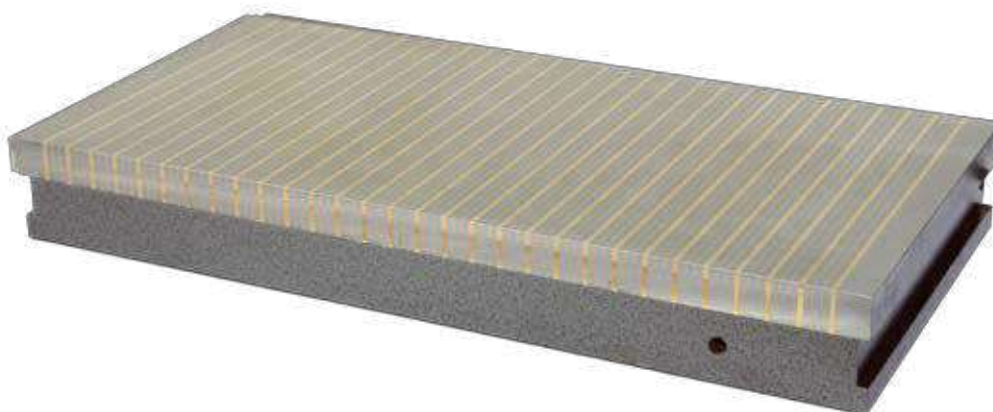

Model	Item-Nr.	Dimensions (mm)			Weight (kg)
		L	B	H	
UGP 8040	2203 08040	800	400	73	163
UGP 9040	2203 09040	900	400	73	183
UGP 10040	2203 10040	1000	400	73	203
UGP 12040	2203 12040	1200	400	73	270
UGP 15040	2203 15040	1500	400	83	337
UGP 20040	2203 20040	2000	400	83	449
UGP 6050	2203 06050	600	500	73	157
UGP 10050	2203 10050	1000	500	73	348
UGP 12050	2203 12050	1200	500	73	348
UGP 15050	2203 15050	1500	500	83	434
UGP 12060	2203 12060	1200	600	73	430
UGP 15060	2203 15060	1500	600	83	538
Other dimensions on request!					

### Structure:

Electro-Permanent Magnet system  
 Steel body + Pole  
 Transverse or longitudinal pole pitch 15+3mm  
 Holding power ca. 110 N/cm<sup>2</sup>  
 Magnetic field Height ca. 8 mm  
 Pole plate wearing limit 7 mm  
 Performance DC Impulse  
 Protection IP 67

### Recommendation:

Precise electro-permanent chipboard for grinding large workpieces.

The standard package includes 3m connection cable and a long and a short side stop bar. Matching pole-reversal devices type ST 211 GR are also available on Pages 99-100

TIP: EFP magnetic clamping plates can be used on most built-in Pole-reversal devices in European grinders.

## TFP Electro-Permanent Magnetic Chucks

TFP electro-permanent magnetic clamping plates with a fine pole division combine the advantages of permanent and electro-magnetic chucks. The particle board does not heat up during long chip times, has a very controlled magnetic field and offers the possibility of holding force control and demagnetization. TFP magnetic chucks designed for grinding and eroding the highest precision - even on small workpieces. They impress with uniform holding force over the entire gripping range. TFP magnetic chucks have a pole-less structure and are therefore particularly flat, very easily and in many places machinable. Optionally there TFP magnetic clamping plates with brass or Epoxyd-resin-isolation. The favorable Epoxyd-resin-isolation has a poorer heat dissipation. Also available with flushing drilling for eroding.

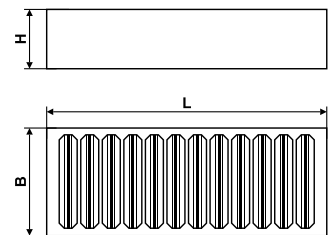

### Structure:

Electro-Permanent Magnet system,  
Steel body, Monoblock  
Transverse or longitudinal pole pitch  
5+5mm with steps.  
(Brass or Epoxid-resin-isolation)  
Holding power ca. 100 N/cm<sup>2</sup>  
Magnetic field Height ca. 4 mm  
Pole plate wearing limit 5 mm  
Performance 210 V Impulse  
Protection IP 67

### Recommendation:

High-precision super flat electro-permanent chipboard for grinding and eroding.

The standard package includes 2m connection cable. Matching pole-reversal devices type ST 211 GR are also available on Pages 99-100

Model	Item-Nr. Brass-isol.	Item-Nr. Epoxydresiniso.	Dimensions (mm)			Weight (kg)
			L	W	H	
TFP 4020	2702 04020	2703 04020	400	200	54	30
TFP 5020	2702 05020	2703 05020	500	200	54	38
TFP 6020	2702 06020	2703 06020	600	200	54	45
TFP 7520	2702 07520	2703 07520	750	200	54	56
TFP 5025	2702 05025	2703 05025	500	250	54	47
TFP 6025	2702 06025	2703 06025	600	250	54	57
TFP 5030	2702 05030	2703 05030	500	300	54	57
TFP 6030	2702 06030	2703 06030	600	300	54	68
TFP 7030	2702 07030	2703 07030	700	300	54	80
TFP 8030	2702 08030	2703 08030	800	300	54	91
TFP 10030	2702 10030	2703 10030	1000	300	54	114
TFP 12030	2702 12030	2703 12030	1200	300	54	136
TFP 5040	2702 05040	2703 05040	500	400	54	76
TFP 6040	2702 06040	2703 06040	600	400	54	92
TFP 7040	2702 07040	2703 07040	700	400	54	108
TFP 8040	2702 08040	2703 08040	800	400	54	122
TFP 10040	2702 10040	2703 10040	1000	400	54	152
TFP 12040	2702 12040	2703 12040	1200	400	54	182
TFP 5050	2702 05050	2703 05050	500	500	54	95
TFP 6050	2702 06050	2703 06050	600	500	54	115
TFP 8050	2702 08050	2703 08050	800	500	54	152
TFP 10050	2702 10050	2703 10050	1000	500	54	190
TFP 12050	2702 12050	2703 12050	1200	500	54	228
TFP 6060	2702 06060	2703 06060	600	600	54	140
TFP 8060	2702 08060	2703 08060	800	600	54	188
TFP 10060	2702 10060	2703 10060	1000	600	54	235
TFP 12060	2702 12060	2703 12060	1200	600	54	282

Other dimensions on request!

## QX Electro-Permanent Magnetic Systems

For milling of medium and large workpieces to the square pole - magnet technology has proven to the world as the best workholding. Extremely short set-up times, vibration-free and interference-contour-free tensioning speak for your use of precision mechanics to shipbuilding.



QX HD 70 with pole extensions for handling fuel cuts

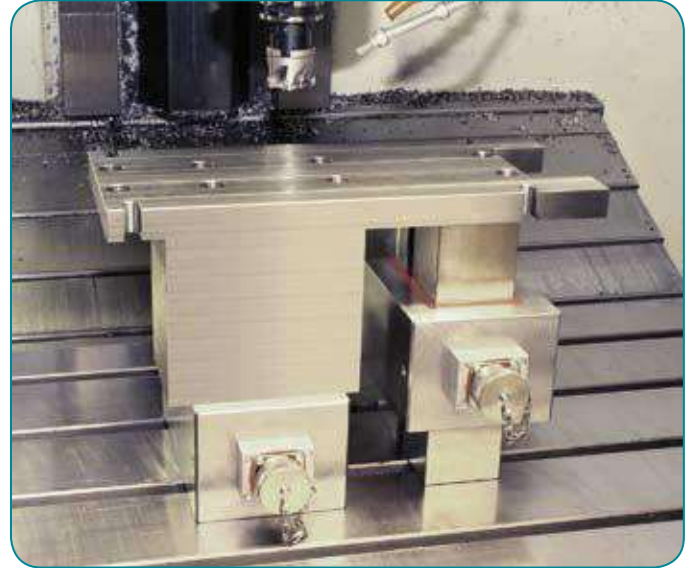

QX-Block 5-axis machining

- Vibration-free machining and clamping of workpieces
- Fast and secure clamping of uneven parts
- Distorting uniform clamping force over the entire surface, without distorting the workpiece
- Five sided machining without crash risk
- Full use of the traverse
- minimal set-up times
- Quickly and accurately plane parallel milling
- Clamping warped weldments in the shortest time
- Fast assembly of individual magnetic clamping devices
- Same holding force in all directions through square pole technology



2 x QX HD 50 on columns for deep drilling

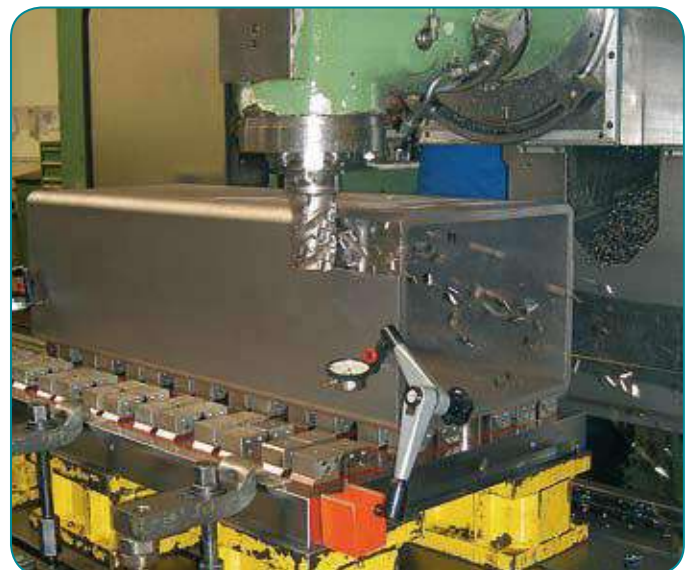

QX HD 50 with pole extensions for working with low vibrations

## QX Electro-Permanent Magnetic Systems

The advanced technology QX comes with intelligent improvements, both mechanically and magnetically. By using coherent Block-pole-field in the monolithic frame construction of the magnetic chuck stiffness was significantly increased - despite lower overall height. Similarly, the revolutionary block field technology reduces Epoxyd-resin-areas and improves the magnetic holding force and the air gap behavior. The thread in the soft magnetic poles are fitted with wear-resistant tool steel inserts.

QX magnetic clamping plates are available in different heights and in clamping blocks. There are two different pole sizes to choose from. Depending mainly to expected workpiece geometry, choosing between poles of size 50x50mm or 70x70mm.

Pole size 50x50mm generate a magnetic field that penetrates the workpiece about 12 mm, which is why they are suitable especially for thinner and smaller workpieces. Another advantage is that especially in smaller workpieces more pole transitions are used, which ensures a more uniform stress. The compared to 70x70mm pole poorer air gap behavior and the higher up effort (longer pole extensions) must be mentioned as a disadvantage. The nominal holding force is super strong  $160 \text{ N / cm}^2 = 4 \text{ kN per pole}$ .

Pole size 70x70mm generate a magnetic field that penetrates the workpiece about 18 mm, which is why they are suitable especially for larger workpieces. The excellent air gap behavior also allows uneven workpieces securely tighten. In addition, on the 70 poles pole extensions higher lift can be used (height adjustment). The nominal holding force is super strong  $160 \text{ N / cm}^2 = 7.8 \text{ kN per pole}$ .

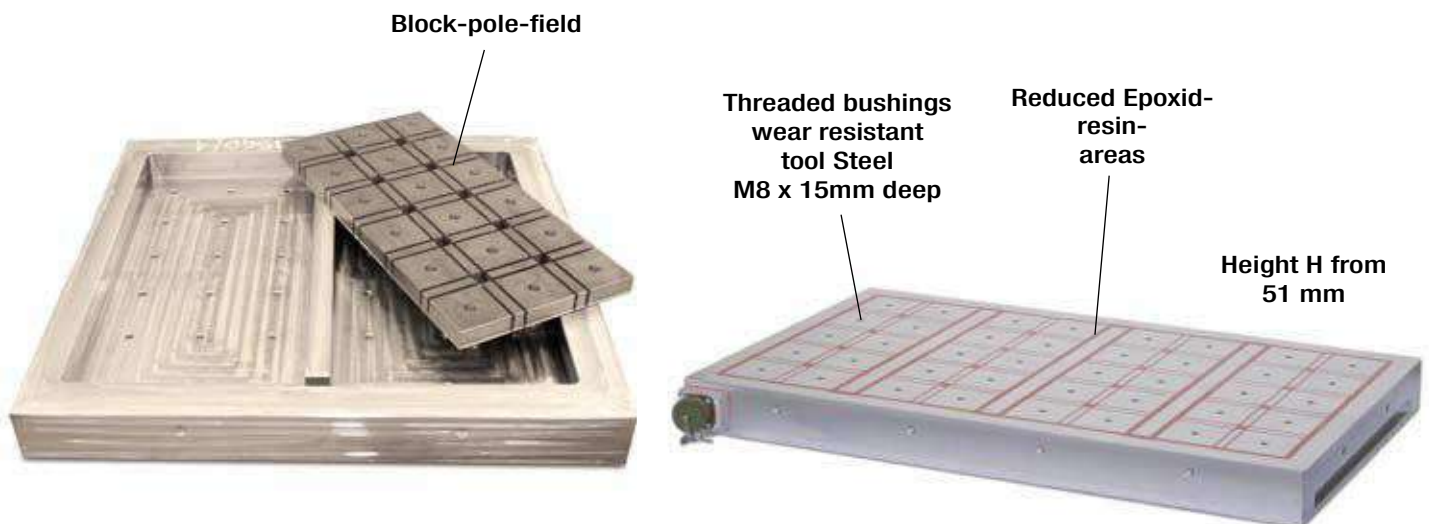

## QX-HE50 Electro-Permanent Magnetic Chucks

Superlight, magnetic chuck in QX technology with 50 poles and only 51mm height. The HE50 is designed for tool- and machine-building. It is suitable for holding small and thin-walled workpieces on fast and light machines. Mounting slots on two sides and the possibility to drill through the magnetic chuck in many places allows a quick and flexible installation.



### QX HE50 Magnetic Chucks

Model	Item-Nr.	Dimensions (mm)			Number Poles° N	Weight (kg)	Matching control unit*
		L	W	H			
QX 204 HE50	2520 204	200	400	51	10	30	ST211ER
QX 205 HE50	2520 205	200	490	51	12	40	ST211ER
QX 206 HE50	2520 206	200	620	51	16	50	ST211ER
QX 208 HE50	2520 208	200	780	51	20	60	ST211ER
QX 209 HE50	2520 209	200	910	51	24	70	ST211ER
QX 210 HE50	2520 210	200	1040	51	28	80	ST211ER
QX 305 HE50	2520 305	270	490	51	18	50	ST211ER
QX 306 HE50	2520 306	270	620	51	24	65	ST211ER
QX 308 HE50	2520 308	270	780	51	30	80	ST211ER
QX 309 HE50	2520 309	270	910	51	36	90	ST211ER
QX 310 HE50	2520 310	270	1040	51	42	105	ST211ER
QX 403 HE50	2520 403	400	330	51	20	50	ST211ER
QX 405 HE50	2520 405	400	490	51	30	75	ST211ER
QX 406 HE50	2520 406	400	620	51	40	90	ST211ER
QX 408 HE50	2520 408	400	780	51	50	115	ST211ER
QX 409 HE50	2520 409	400	910	51	60	135	ST211ER
QX 410 HE50	2520 410	400	1040	51	70	150	ST211ER
QX 505 HE50	2520 505	470	490	51	36	85	ST211ER
QX 506 HE50	2520 506	470	620	51	48	110	ST211ER
QX 508 HE50	2520 508	470	780	51	60	135	ST211ER
QX 509 HE50	2520 509	470	910	51	72	155	ST211ER
QX 510 HE50	2520 510	470	1040	51	84	180	ST211ER
QX 605 HE50	2520 605	600	490	51	48	110	ST211ER
QX 606 HE50	2520 606	600	620	51	64	135	ST211ER
QX 608 HE50	2520 608	600	780	51	80	170	ST211ER
QX 609 HE50	2520 609	600	910	51	96	200	ST211ER

\* Control unit not included, Selection on Pages 99

## QX-LOCK HD50 Electro-Permanent Magnetic Chucks

QX Lock magnetic chucks are equipped with an extra strong frame construction. The overall height is 68mm and the rear panels can be drilled 22mm deep or 12mm milled. Optimal for introducing reference elements for zero-point clamping systems. Transport thread around the plate allows an easy horizontal and vertical transport by crane.



### QX-Lock HD50 Magnetic Chucks

Model	Item-Nr.	Dimensions (mm)			Number Poles °N	Weight (kg)	Matching Control unit *
		L	W	H			
QX-Lock 402 HD50	2419 402	399	199	68	10	39	ST211 Feme
QX-Lock 404 HD50	2419 404	399	399	68	24	78	ST211 Feme
QX-Lock 406 HD50	2419 406	599	399	68	40	118	ST211 Feme
QX-Lock 408 HD50	2419 408	799	399	68	50	156	ST211 Feme
QX-Lock 410 HD50	2419 410	999	399	68	60	195	ST211 Feme
QX-Lock 505 HD50	2419 505	499	499	68	36	122	ST211 Feme
QX-Lock 506 HE50	2419 506	620	470	68	48	132	ST211 Feme
QX-Lock 508 HE50	2419 508	770	470	68	60	162	ST211 Feme
QX-Lock 510 HE50	2419 510	1040	470	68	84	282	ST211 Feme
QX-Lock 606 HE50	2419 606	620	600	68	64	172	ST211 Feme
QX-Lock 608 HE50	2419 608	700	680	68	80	212	ST211 Feme
QX-Lock 612 HD50	2419 612	1114	600	68	112	322	ST214 Feme

\* Control unit not included, Selection on Pages 99

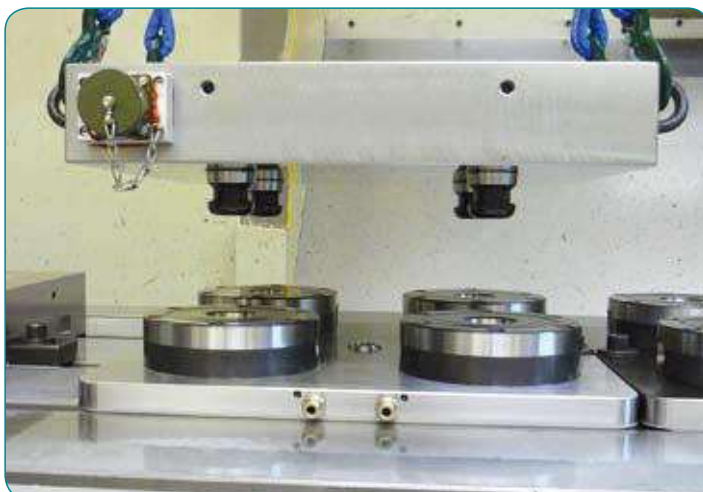

Magnetic clamping- and zero-point-Technic complete your productivity! Look from page 101

## QX-RD50 Electro-Permanent Magnetic Chucks

Round magnetic clamping plates with QX square poles are especially suitable for machining centers with roundtable and for turning and milling. The QX - RD50 magnetic clamping plates can be manufactured in 51mm or 68mm height, standard with side plug connection but also with sliding contacts for shaft bushing.

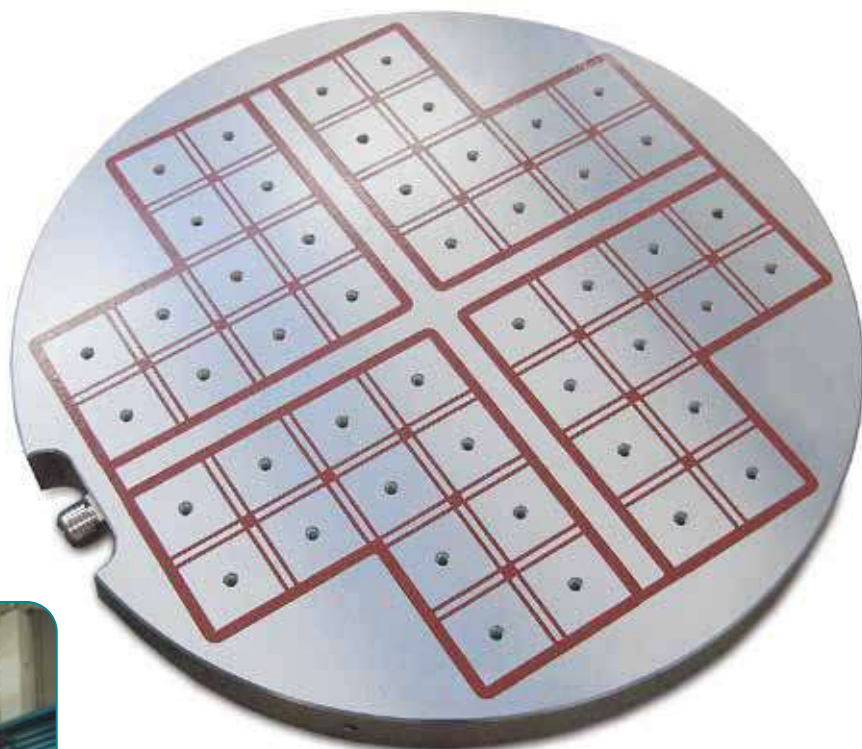

### QX RD50 Magnetic Chucks

Model	Item-Nr.	Dimensions (mm)		Number Poles °N	Weight (kg)	Matching Control units *
		ØD	H			
QX 500 RD50	2428 0500	500	51	32	70	ST211 ER
QX 600 RD50	2428 0600	600	51	52	110	ST211 ER
QX 800 RD50	2428 0800	800	51	80	180	ST211 ER
QX 1000 RD50	2428 1000	1000	51	112	325	ST211 ER
QX 1200 RD50	2428 1200	1200	68	200	650	ST212 FEME

\* Control unit not included, Selection on Pages 99



## QX-HD70 Electro-Permanent Magnetic Chucks

Version with 70x70mm Poles for processing primarily large workpieces. Available in light 51mm or 68mm height. QX - HD70 is compatible with the world's best-selling magnetic clamping systems for heavy cutting. Mounting slots on two sides and the ability to pierce the magnetic chuck in many places allows a quick, flexible installation. In the version with height 68mm, deep rear 22mm can be drilled.

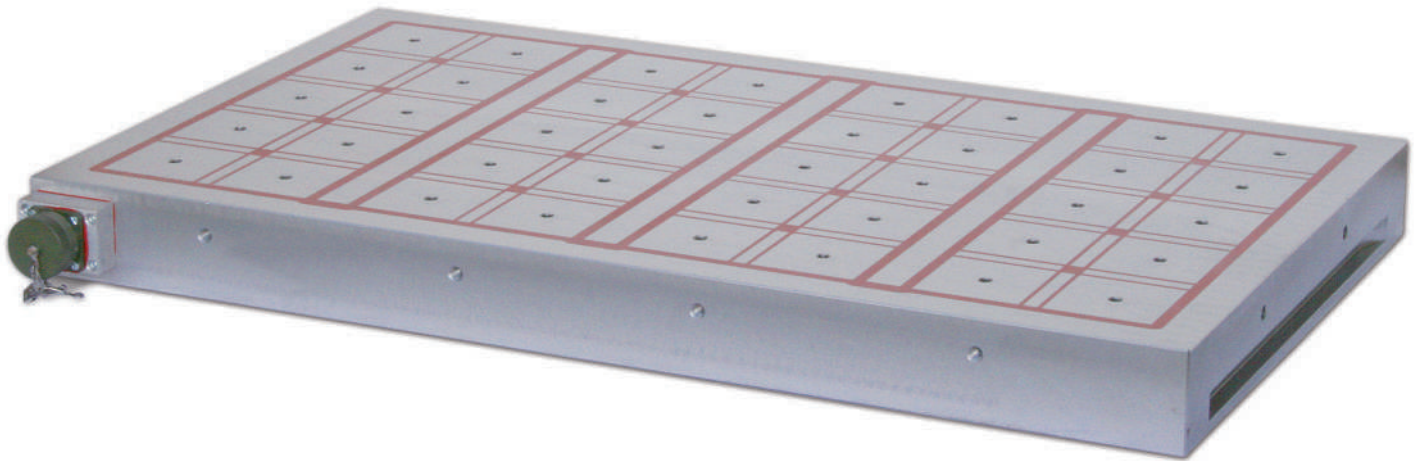

QX HD70 Magnetic Chucks H=68 mm

Model	Item-Nr.	Dimensions (mm)			Number Poles °N	Weight (kg)	Matching Control units *
		L	W	H			
QX 406 HD70	2421 406-1	390	610	68	24	110	ST211 Feme
QX 408 HD70	2421 408-1	390	810	68	32	150	ST211 Feme
QX 410 HD70	2421 410-1	390	1000	68	40	185	ST211 Feme
QX 506 HD70	2421 506-1	480	610	68	30	140	ST211 Feme
QX 508 HD70	2421 508-1	480	810	68	40	185	ST211 Feme
QX 510 HD70	2421 510-1	480	1000	68	50	228	ST211 Feme
QX 606 HD70	2421 606-1	580	610	68	36	165	ST211 Feme
QX 608 HD70	2421 608-1	580	810	68	48	220	ST211 Feme
QX 610 HD70	2421 610-1	580	1000	68	60	275	ST211 Feme
QX 612 HD70	2419 612-70	580	1200	68	72	322	ST211 Feme
QX 808 HD70	2419 9029	800	800	68	64	292	ST211 Feme

\* Control unit not included, Selection on Pages 99

All clamping Chucks in 68 mm height are compatible ECUs in 400V technology, which will be delivered since 1998. In der Regel haben diese einen 4 Pin / 28 mm Bajonettstecker. In general, these have a 4-pin / 28 mm bayonet connector.

## QX-BLOCK HD70 Electro-Permanent Magnetic Blocks

QX block is a two-sided active, flexible operating magnetic clamping block. Each side has two / four 70mm QX Poles - equipped with a total 15.6 / 31.2kN resilience. It can be used to secure workpieces flexibly or as an additive in order to avoid tightening element, especially at high clamping vibrations. The standard height of 100,2mm can be reduced by 6mm. Likewise, both sides with standard pole extensions can be fixed or mobile provided. There are heights between 94mm and 240mm realized. The QX block is driven by a ST 211 Feme or by almost any standard 400V pole-reversal device. With distribution boxes, several QX block can be driven simultaneously.



### QX-Block

Model	Item-Nr.	Dimensions (mm)			Number Poles °N	Weight (kg)	Matching Control units *
		L	B	H			
QX-Block 201 HD70	2480 070	220	130	100	2 + 2	20	ST211 Feme
QX-Block 401 HD70	2480 071	390	130	100	4 + 4	39	ST211 Feme

\* Control unit not included, Selection on Pages 99

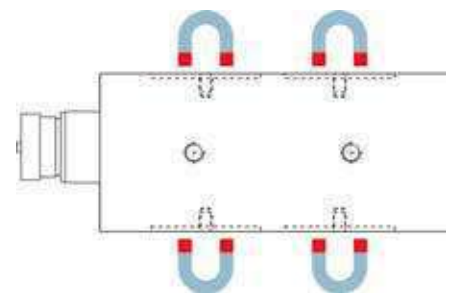
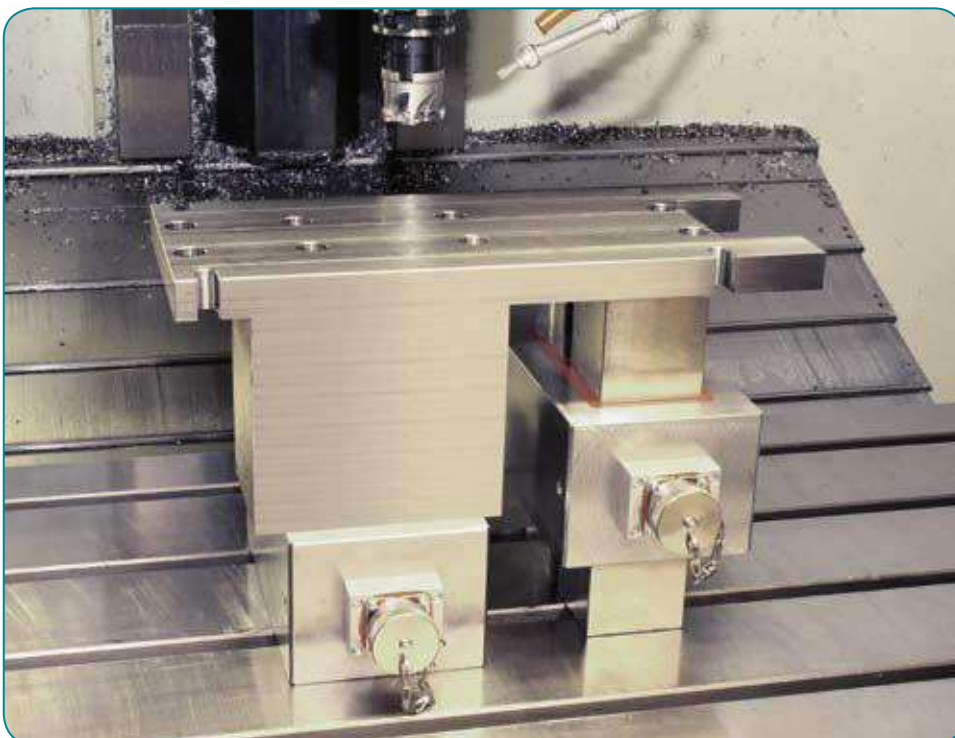

**2 magnetic active Sides!**

## UNI-MILL Block HD50 Electro-Permanent Magnetic Block

The Uni-Mill block can operate as a vertical clamping plane on horizontal magnetic chucks or are simply bracketed on the machine table. It is suitable for mounting on the end-face machining on vertical machining centers as well as a quick-change base on 5-axis machines. The Uni-MILL block is driven by a ST 211 Feme or by almost any standard 400V pole-reversal device. With distribution boxes, several Uni-MILL blocks can be driven simultaneously.



UNI-MILL HD50 Magnetic Block

Model	Item-Nr.	Dimensions (mm)			Number Poles °N	Weight (kg)	Performance	Matching Control units *
		L	W	H				
UMB 8/50 ER	2480 010	310	230	95	8	50	230V	ST211 ER
UMB 8/50 Feme	2480 011	310	230	95	8	50	400V	ST211 Feme

\* Control unit not included, Selection on Pages 99

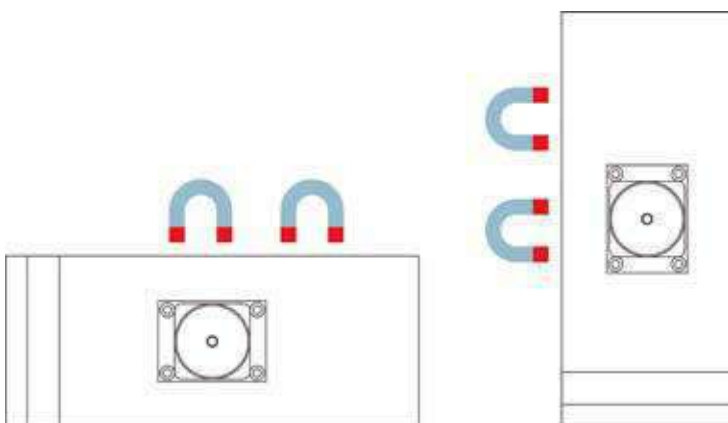

The UNI-MILL magnetic clamping block can be mounted vertically and horizontally on the machine table or on a magnetic chuck.

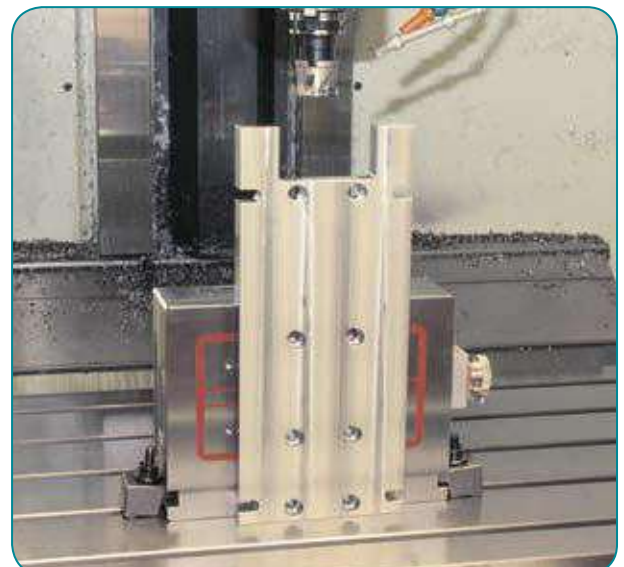

## MILL-TEC Electro-Permanent Magnetic Chucks

The new, patented Mill-Tec System has revolutionized clamping in many applications. The double-acting magnetic chuck clamped itself magnetically to the machine table and holds the workpiece on the top. This new technology provides even more stiffness and eliminates all avoidable vibration. The magnetic chuck is made of one piece, slim 42mm tall and has a fully metallic clamping surface. The top and bottom can be controlled separately, so that the magnetic chuck securely maintains its position even when changing the workpieces. Round poles with a diameter of 70mm for maximum holding force of 160 N / cm<sup>2</sup> active area. The intermediate portions of the poles can be machined and fitted with positioning or stops. On the equipment side of the table a high demagnetizing cycle ensures that the degradation of chipboard remains no magnetism.

Both the flexible positioning of multiple chucks for machining of large parts, as well as the extremely fast change of the clamping device in fabricating small and medium sized parts, the Mill - Tec shines through time savings and flexibility.

To clamp workpieces with uneven surfaces or for raising of workpieces round pole extensions mobile (RMP type 78) and fixed (PVR 70) can be used.



### Mill-Tec Magnetic Chucks

Model	Item-Nr.	Dimensions (mm)			Number Poles° N	Weight (kg)	Matching Control units *
		L	W	H			
Mill-Tec 304	2431 304	320	420	42	12	40	ST200 SK
Mill-Tec 306	2431 306	320	600	42	18	55	ST200 SK
Mill-Tec 308	2431 308	320	785	42	24	75	ST200 SK
Mill-Tec 310	2431 310	320	970	42	30	90	ST200 SK
Mill-Tec 404	2431 404	405	420	42	16	50	ST200 SK
Mill-Tec 405	2431 405	405	500	42	20	70	ST200 SK
Mill-Tec 406	2431 406	405	600	42	24	90	ST200 SK
Mill-Tec 408	2431 408	405	785	42	32	115	ST200 SK
Mill-Tec 410	2431 410	405	970	42	40	55	ST200 SK
Mill-Tec 506	2431 506	485	600	42	30	80	ST200 SK
Mill-Tec 508	2431 508	485	785	42	40	105	ST200 SK
Mill-Tec 510	2431 510	485	970	42	50	130	ST200 SK
Mill-Tec 606	2431 606	570	600	42	36	95	ST200 SK
Mill-Tec 608	2431 608	570	785	42	48	125	ST200 SK
Mill-Tec 610	2431 610	570	970	42	60	155	ST200 SK

\* Control unit not included, Selection on Pages 99

## MAG-VAC Magnet-Vacuum Hybrid System

The patented MAG VAC technique allows a magnetic chuck in a few seconds to convert a vacuum chuck. This solution is particularly attractive when the magnetic chuck is usually not or only rarely is removed from the machine and both magnetizable and non- magnetizable workpieces to be processed.

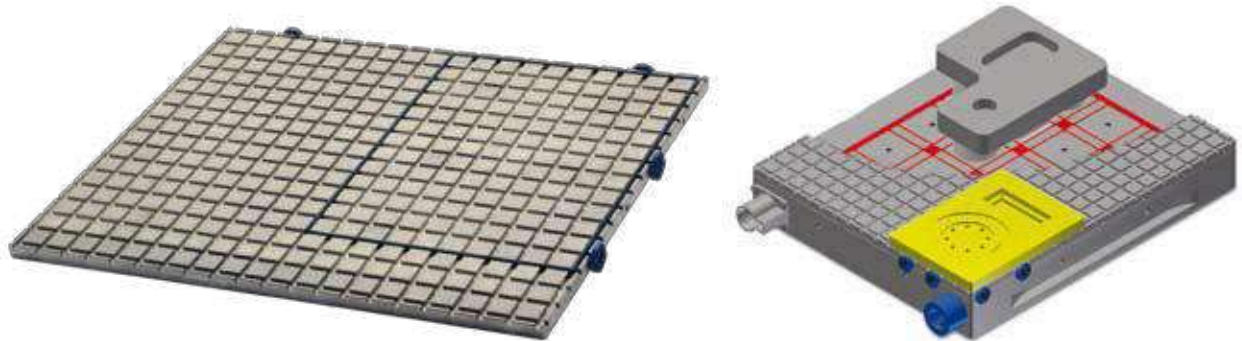

### Easy conversion:

In the MAG - VAC -compatible electro-permanent magnetic chuck the MAG VAC Grid adapter plate is placed, pushed into position and clamped magnetically. After that, the hose of a commercial vacuum port is connected to the magnetic clamping plate - done.



**Step 1:**  
Positioning the MAC VAC  
GRID adapter plate



**Step 2:**  
Activating the Magnetic  
Chuck

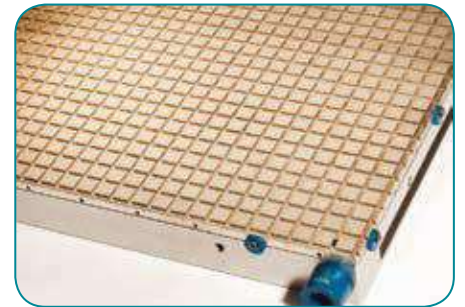

**Step 3:**  
Connecting the vacuum  
pump - ready

MAG VAC standards are available in sizes 50 and QX QX 403 HE 406 HE 50, but any other QX magnetic chuck in our range can be supplied as MAG - VAC system. Likewise, it is possible to retrofit existing plates.

Model	Item-Nr.	Dimensions (mm)			Number Poles° N	Weight (kg)	Matching Control units*
		L	W	H			
QX 403 HE50	2520 403	400	330	51	20	50	ST211 ER
QX 406 HE50	2520 406	400	620	51	40	90	ST211 ER

\* Control unit not included, Selection on Pages 99

Optionally, the clamping possibilities of working with sealing cord GRID be expanded adapter plate through the use of SLOT PLATE grooved plate or the VAC - MAT chamber plate. Attractive if from thin materials workpieces have to be milled.



GRID Adapter-plate

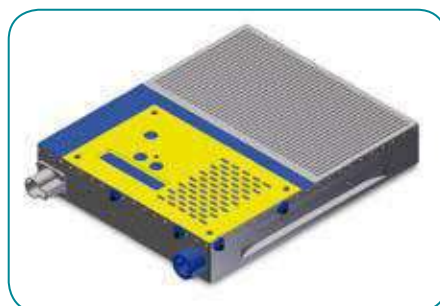

SLOT-PLATE

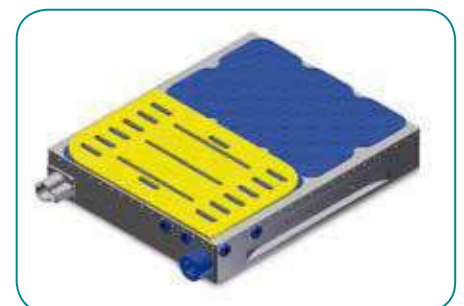

VAC-MAT

## QX / MILL-TEC Supplies

Mobile and fixed pole extensions to the square pole - mounting system allow the clamping of wavy and warped metal parts. They adapt to your workpiece and keep it safe. Individually each of contact points between magnetic chuck and workpiece can be defined. Also, the through drilling and the editing of the inner edges of magnetically clamped workpieces is possible. Additional pole extensions can be build, installed or removed in a very short time, so each piece has his individual fixture. For five -sided machining the workpiece can be released with pole extensions. About pole plates complex structures can be incorporated to exciting workpieces in the magnetically active area. Our pole extensions are made of high quality steel and have the best magnetic flux properties - technically perfect and durable.



- Vibration-free machining and clamping of workpieces
- Protection of the magnetic chuck
- Flexibility in mounting height
- Interference-contour free / through-drilling and milling possible
- No vacuum adhesion between magnetic chuck and workpiece
- Easy solving of the workpiece even with highly alloyed / hardened materials

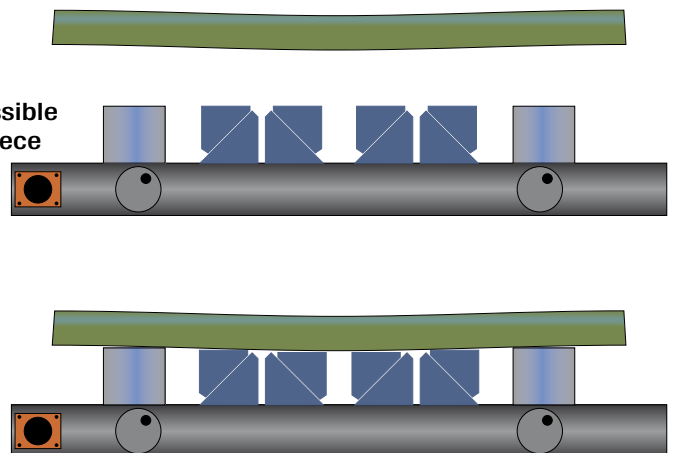

Fixed three-point support with 3 solid Pole extensions and mobile Pole extensions for auto Adaptation to the workpiece.

### Quick Parallelism

Scrub the 1. area

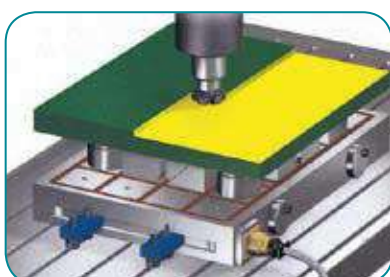

Turn and scrub the 2. area

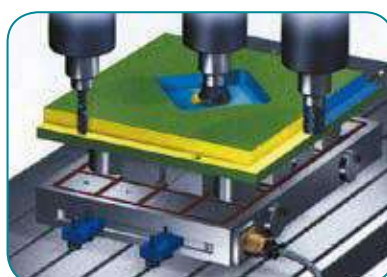

Turn and settle the 1. area

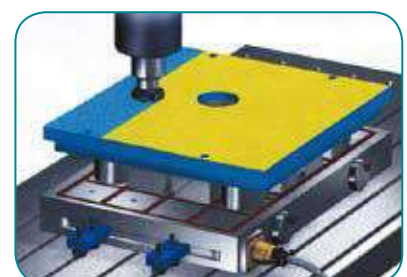

## QX / Mill-Tec Supplies Standard Pole Extensions

Fixed pole extensions are used to specify the three-point support when used in conjunction with mobile pole extensions or high note to inherently rigid flat materials. By using a full assembly of fixed pole extensions, the magnetic chuck is protected from wear and defects. In case of wear, the pole extensions can be milled again and again.



One pole, round

Model	Item-Nr.	Dimensions (mm)	
		Ø	H
PVR 50 H15	2410 15031-15	50	15 ±0,01
PVR 50 H32	2410 15031	50	32 ±0,01
PVR 70 H20	2410 17021	70	20 ±0,01
PVR 70 H45	2410 17043	70	45 ±0,01



One pole, square

Model	Item-Nr.	Dimensions (mm)		
		L x B	H	
PVQ 50 H15	2410 15032-15	50 x 50	15 ±0,01	
PVQ 50 H32	2410 15032-1	50 x 50	32 ±0,01	
PVQ 50 H54	2410 15032-54	50 x 50	54 ±0,01	
PVQ 70 H20	2410 17020-1	70 x 70	20 ±0,01	
PVQ 70 H45	2410 17045-1	70 x 70	45 ±0,01	
PVQ 70 H70	2410 17020-2	70 x 70	70 ±0,01	

## QX / MILL-TEC Supplies Mobile Pole Extensions

Mobile pole extensions RMP type are simply screwed manually via the threaded pin is turned (M8 x 10mm) to the magnetic chuck. The surface of the RMP pole extension is completely processed and chemically nickel-plated. The magnetic performance is compared to the standard square pole extension higher by about 20% and the closed design largely prevents the penetration of dirt and chips. The round design generates a purely vertical stroke. The clamping surface is sandblasted to increase the friction. The version RMP 78-1 also enables thin-walled parts with 14mm to magnetic clamping plates with 70 / 75er square poles or on the Mill - Tec sure to stretch.

## MP Mobile Standard Pole Extensions

Mobile pole extensions MP be screwed with an Allen key to the magnetic poles. The surface of the MP pole-extension is blasted and electrolytically plated. Mobile pole extensions are used to clamp workpieces entire surface and without warping. Over the inclined plane, the upper part of the pole extension moves to the level of the workpiece and stiffens this without down effect.



MP 50 H32 / MP 70 H45  
Shell secured by  
Guide.

An advantage of vertical stretch!



MP 50 H54

Shell floating freely, allowing maximum height adjustment and easy cleaning!



MP 70 H70

Model	Item-Nr.	Matching for Poles	Dimensions (mm)			Matching on fixed Pole-Extensions	Weight (kg)
			L	W	H		
MP 50 H32	2410 35032	50 mm	50	50	29 - 35	H = 32mm	0,5
MP 50 H54	2410 35054	50 mm	50	50	44 - 59	H = 54mm	1
MP 70 H45	2410 37045	70/75mm	70	70	40,5 - 50,5	H = 45mm	1,5
MP 70 H70	2410 37070	70/75mm	70	70	60 - 75	H = 70mm	2,5

Mounting screws M8 included!

## RMP Mobile Pole Extensions

Mobile pole extensions RMP type are simply screwed manually via the threaded pin is turned (M8 x 10mm) to the magnetic chuck. The surface of the RMP pole extension is completely processed and chemically nickel-plated. The magnetic performance is compared to the standard square pole extension higher by about 20% and the closed design largely prevents the penetration of dirt and chips. The round design generates a purely vertical stroke. The clamping surface is sandblasted to increase the friction. The version RMP 78-1 also enables thin-walled parts with 14mm to magnetic clamping plates with 70 / 75er square poles or on the Mill - Tec sure to stretch.

Model	Item-Nr.	Matching for Poles	Dimensions (mm)		Matching on fixed Pole-Extensions	Weight (kg)
			Ø	H		
RMP 57	2420 057	50 mm	57	29,5 - 34,5	H = 32mm	0,5
RMP 78	2420 078	70/75mm	78	40 - 47,5	H = 45mm	1,2
RMP 78-1	2420 078-1	70/75mm	78	40 - 47,5	H = 45mm	1,2



RMP 78-1



RMP 57 / RMP 78



## QX / MILL-TEC Supplies Full Metal Pole Plates

Full Metal pole plates of the type SMS 50 and SMS 70 can be built on QX and Mill - Tec magnetic chucks. The pole plates are made with a special shrinking-method and therefore are extremely stiff. When milling under extreme conditions, SMS pole plates protect the magnetic clamping system. For devices for serial production slots, stops, strokes, and the like can be introduced into the magnetically active, mechanically workable surface. For automated applications compressed air-outlets can be incorporated in the pole plate for cleaning the pole plates as well as for the safe releasing of the workpieces. The size of the pole plates is custom-defined, depending on requirements and application. Heights between 22mm and 62mm can be realized. The use of magnetic clamping plate pole + SMS has proven itself to weld 3D sheet metal parts well.





## QX / MILL-TEC Supplies Multiple Pole Plates

Multiple pole plates allow to create large magnetically active areas with work-in opportunities. Thus, e.g. with maximum stiffness contours and workpiece shapes are introduced into the pole surface. Complex, hardly to clamp workpieces of cast iron or steel can be easily inserted into your form. Similarly, a vertical, active tension profile can be created in order to create workpieces or in addition to stabilize. Pole plates and multiple poles are “soft jaws” for your clamping system.

### 2-part Pole-plates



Model	Item-Nr.	For Pole-size	Dimensions (mm)			
			L	W	H	LA
PP 50 H32-2	2410 15032-2	50x50mm	110,2	50	32 ±0,01	60,2
PP 50 H38-2	2410 15033-2	50x50mm	110,2	50	38 ±0,01	60,2
PP 70 H45-2	2410 17045-2	70x70mm	155,2	70	45 ±0,01	85,2
PP 70 H55-2	2410 17046-2	70x70mm	155,2	70	55 ±0,01	85,2

Mounting screws M8 included!

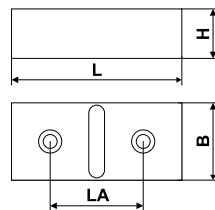

Multiple pole plates we offer in ground height for use with the matching mobile pole extensions or alternatively with 6mm or 10mm allowance for introducing its own contours, edges or prisms.

## QX / MILL-TEC Supplies Multiple Pole Plates

### 4-part Pole-plates

Model	Item-Nr.	For Pole-size	Dimensions (mm)			
			L	W	H	LA
PP 50 H32-4	2410 15032-4	50x50mm	110,2	110,2	32 ±0,01	60,2
PP 50 H38-4	2410 15033-4	50x50mm	110,2	110,2	38 ±0,01	60,2
PP 70 H45-4	2410 17045-4	70x70mm	155,2	155,2	45 ±0,01	85,2
PP 70 H55-4	2410 17046-4	70x70mm	155,2	155,2	55 ±0,01	85,2

Mounting screws M8 included!

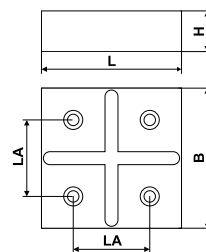

### 8-part Pole-plates

Model	Item-Nr.	For Pole-size	Dimensions (mm)			
			L	W	H	LA
PP 50 H32-8	2410 15032-8	50x50mm	230,6	110,2	32 ±0,01	60,2
PP 50 H38-8	2410 15033-8	50x50mm	230,6	110,2	38 ±0,01	60,2
PP 70 H45-8	2410 17045-8	70x70mm	325,6	155,2	45 ±0,01	85,2
PP 70 H55-8	2410 17046-8	70x70mm	325,6	155,2	55 ±0,01	85,2

Mounting screws M8 included!

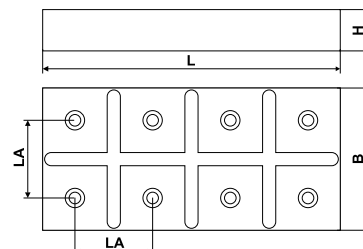

## QX / MILL-TEC Supplies Multiple Special Pole Plates

For a repeatable build on QX clamping systems, we offer you all pole plates with optional rear fits and Bushes, too. Customer side, the corresponding adjustment (diameter 15mm / M6) must then be introduced into the magnetic chuck. So recurring workpieces can be clamped in the prepared position.

### Delivery:

Selected standard pole + Work-in + Bushes + Screws + -  
Drawing for introducing the counter fit into the magnetic chuck.

Model	Item-Nr.	Dimensions (mm)	
		Ø x HL	W
Bushes	2450 001	15m6 x 10	10
Desired Standard-pole-plate must be ordered!			

Pole plates with stop edge enable rapid insertion and protect magnetically poorly stretchable parts of slipping.

Model	Item-Nr.	Dimensions (mm)	
		Area	H+stop
PP 50 H32+6-2	2410 15035-2	110,2 x 50	32+6
PP 50 H32+6-4	2410 15035-4	110,2 x 110,2	32+6
PP 70 H45+10-2	2410 17048-2	155,2 x 70	45+10
PP 70 H45+10-4	2410 17048-4	155,2 x 155,2	45+10
Mounting-screws M8 included			



## MBR Magnetic Block

MBR magnetic blocks serve as additional support to reduce vibration when the workpiece overhangs the magnetic clamping plate or if 2 magnetic clamping plates are mounted at a large distance. Likewise MBR magnetic clamping blocks can form the 3-point support of the workpiece outside the magnetic chuck. On one side, the MBR is equipped with a powerful permanent magnetic base. The other side is brought to desired height above the massive, self-locking trapezoidal spindle. The MBR allows to set all levels needed for our magnetic clamping systems - from 82mm to 114mm. With additional adapter discs that are simply screwed onto the system, the height (H) can be extended.



Model	Item-Nr.	Dimensions (mm)		Holding power (N)	Weight (kg)
		Ø	H		
MBR 65	2410 0065	65	82 - 114	280	1,8

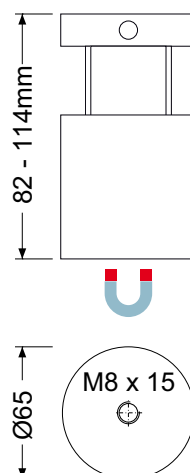

## ST Control Units

The ST-Control units are on the cutting edge of technology. They are short-circuit proof and equipped with a power management, to control the full magnetization. It can be connected either individual chucks or entire tables. An integration into the machine control system is possible. The ST 211 Grind model is equipped with 8 stage holding force regulation and special degauss for controlling the grinding plates.

### Technical Data:

Supply voltage 230V/400 /50 Hz  
 Output voltage Pulse  
 Body IP 44 / Protection class 1  
 100% ED, 0-40 ° C  
 Enable contact for machine safety

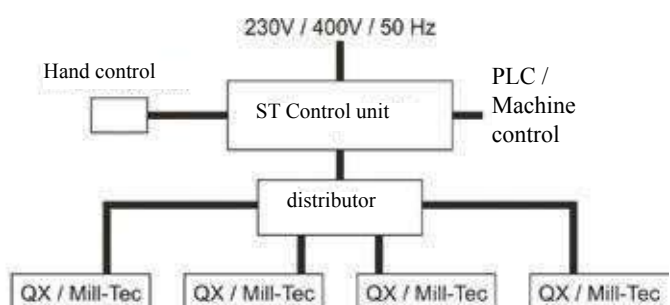
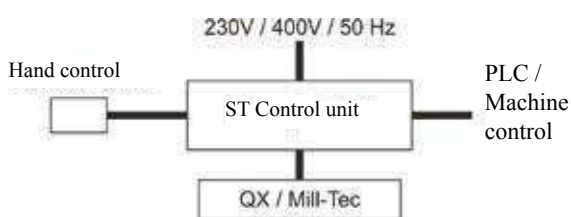
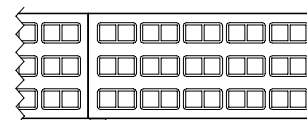
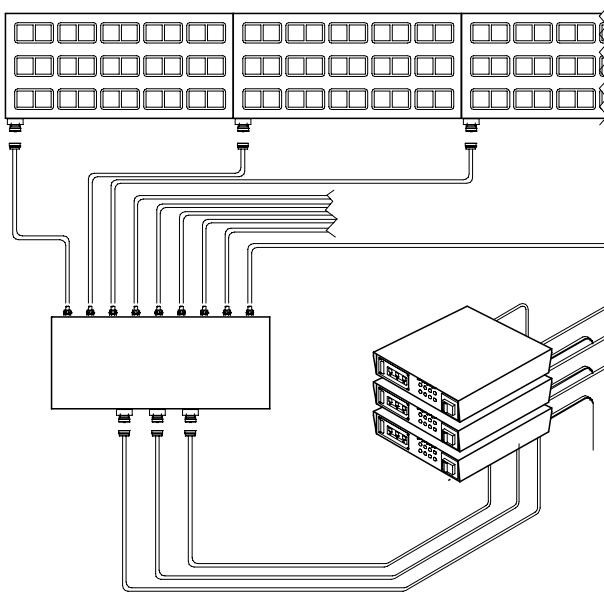

## ST Control Units

Model	Item-Nr.	Weight (kg)	Size (mm)	Supply voltage	Input	Output	Cable length	Plug	Magnetic Chuck
ST 211 ER	9050 1211	11kg	331x275x85	400V/50HZ 25A	3m + 32 A CEE	Leitung	5 Meter	Ergon	QX from 2012
ST 211 SK	2439 211	11kg	331x275x85	400V/50HZ 25A	3m + 32 A CEE	Leitung	5 Meter	Ergon	Milltec
ST 211 Feme	9050 1201	11kg	331x275x85	400V/50HZ 25A	3m + 32 A CEE	Leitung	6 Meter	FEME 4pol	QX 68mm/SQ/QX-Lock/ QC Block/U
ST 212 SK	2439 212	11kg	331x275x85	400V 50HZ/25A	3m + 32 A CEE	Leitung	6 Meter	FEME 4pol	Milltec on distributor
ST 212 Feme	9050 1202	11kg	331x275x85	400V/50HZ/25A	3m + 32 A CEE	Leitung	6 Meter	FEME 4pol	QX on distributor
ST 214 SK	2439 214	11kg	331x275x85	400V 50HZ/25A	3m + 32 A CEE	Leitung	6 Meter	FEME 7pol	Milltec on distributor
ST 214 Feme	9050 1204	11kg	331x275x85	400V/50HZ/25A	3m + 32 A CEE	Leitung	6 Meter	FEME 7pol	QX on distributor
ST 211 GR	9050 1221	11kg	331x275x85	400V/50HZ 25A	3m + 32 A CEE	Leitung	5 Meter	Festanschluss	EFP, TFP, UGP, TFP/C PFR, RP

### Junction boxes made of sheet steel housings, Protection IP 65

Matchcode	Designation	Item-Nr.	Weight (kg)	Size (mm)	input pluggable	Output	Cable	Cable length	Plug
VB1-2 K/ Feme	1 in 2	9050 1502-1	3,5	76x80x58	feme	2x Line	yes	6m	Feme
VB1-2 K/ Ergon	1 in 2	9050 1502-2	3,5	76x80x58	feme	2x Line	yes	5m	Ergon
VB1-2 B/ Feme	1 in 2	9050 1502-3	3	76x80x58	feme	2x Bush	no	none	Feme
VB1-3 K/ Feme	1 in 3	9050 1503-1	8	160x160x90	feme	3x Line	yes	6m	Feme
VB1-3 K/ Ergon	1 in 3	9050 1503-2	7	160x160x90	feme	3x Line	yes	5m	Ergon
VB1-3 B/ Feme	1 in 3	9050 1503-3	3	160x160x90	feme	3x Bush	no	none	Feme
VB1-4 K/ Feme	1 in 4	9050 1504-1	12	160x160x90	feme	4x Line	yes	6m	Feme
VB1-4 K/Ergon	1 in 4	9050 1504-2	10	160x160x90	feme	4x Line	yes	5m	Ergon
VB1-4 B/ Feme	1 in 4	9050 1504-3	3	160x160x90	feme	4x Bush	no	none	Feme

## MCU-FS Safety Foot-Switch

Safety foot-switch with mechanical double press. It allows you to hang up workpieces with both hands and to turn the magnetic clamping system on or off on foot. In particular in the production of serial parts and vertical spread out thus boost effectiveness and safety.

Model	Item-Nr.	Dimensions (mm) L x W x H	Weight (kg)
MCU-FS	2411 010	150 x 150 x 200	6



## Palletizing / Zero Point Clamping Systems

The automation has become indispensable in the mechanical processing. In order to keep machine downtime to a minimum, in EDM, milling and grinding machines, palletizing and zero-point clamping systems are used. This allows the user to span the workpiece already outside the machine, so that a supply of strained workpieces for the machine can be prepared.

This allows zero-point clamping systems, to change workpieces between 2 machines without re- calibration of the position, or even to interrupt a machining operation, to take the workpiece from the machine and to continue to run the program at a known position.

The external clamping is carried on pallets which can be accommodated in the machine repeatably. The pallets are then passed manually or automatically in the machine.

The magnetic clamping plates described on the following pages are suitable for use with palletizing systems from all manufacturers.

To produce self-sustaining magnetic palettes reference elements can also be incorporated directly into the magnetic chuck. We also supply ready-made with original clamping and positioning equipped magnetic pallets for all Systems.

For heavy cutting and large workpieces we recommend Electro-Permanent square pole, in combination with UniLock-R quick-change pallet systems.



UniLock-R Zero-point-clamping-system



RS Magnet circular chuck with System Erowa ITS



PMNM Magnet plate with Reference-elements  
System Erowa UPC



## Palletizing / Zero Point Clamping Systems

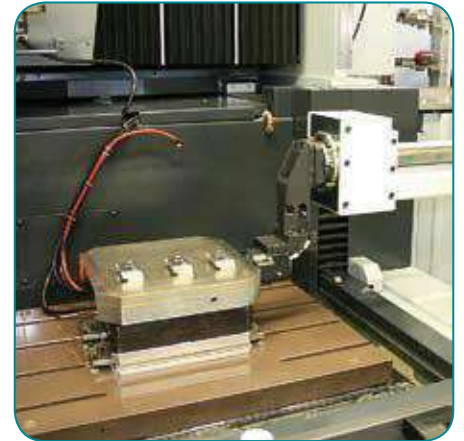
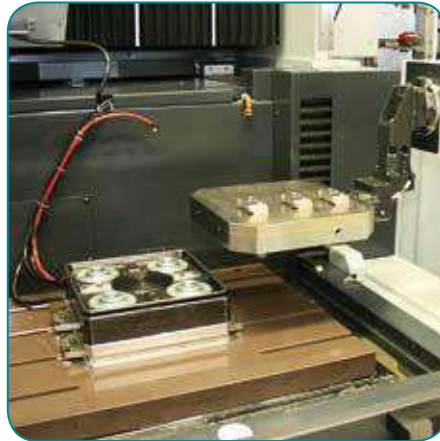
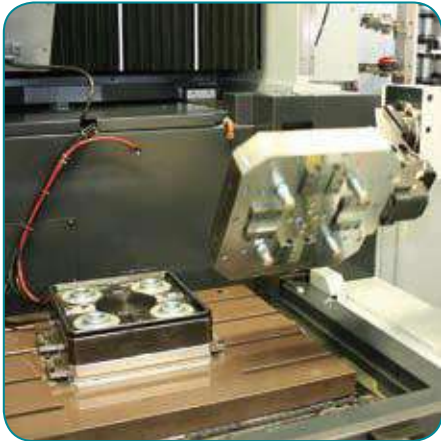

Assembly operation in an EDM machine with palletizing magnetic chucks system Erowa



PMNM-AL permanent  
Magnetic range with reference elements  
System Erowa UPC



Magazine for palletising magnetic chucks and tools



HSC milling on PMNEO

## Palletizing / Zero Point Clamping Systems

For combination with quick-change systems, different magnetic concepts are available depending on the application



### Page 104

PMNM - For eroding and grinding



### Page 106

PMUNI - for eroding and milling small, thin workpieces or especially in combined HSC eroding machines. PMUNI magnet chucks with double magnet system and universal pole division



### Page 107

PMNEO - for HSC milling, also on pole extensions. PMNEO Magnetic chucks with super-strong double magnet system



### Page 108

RS - for grinding, eroding and milling in conjunction with ITS clamping systems



### Page 109

QX-LOCK - for large workpieces, also for pole extensions. Suitable for massive machining



### Page 110

UNI-LOCK - high-precision zero-clamping system

## PMNM Permanent Magnetic Chuck

Permanent magnetic chucks type PMNM are high precision plates for clamping small and thin parts for precision grinding and eroding. The low magnetic field height prevents magnetization of processing tools. The chipboard is activated via a removable hex shifter.



Height 40 mm with steel body, flat and easy to build on standard pallets.

Model	Item-Nr.	Dimensions (mm)			corner chamfer (mm)	Weight (kg)
		L	W	H		
PMNM 1515	2004 1515	150	150	51	-	9
PMNM 2424-40	2019 2424	240	240	40	10 x 45°	18
PMNM 2828-40	2019 2828	280	280	40	10 x 45°	25
PMNM 3232-40	2019 3233	320	320	40	40 x 45°	29
PMNM 4040	2004 4040	400	400	51	40 x 45°	60
Other dimensions on request!						

### Structure:

Neodymium Magnet system, Steel body,  
 Transverse pole pitch 1.4 + 0.5 mm  
 Holding power ca. 100 N/cm<sup>2</sup>  
 Magnetic field height ca. 5 mm  
 Pole plate wearing limit 6 mm

### Recommendation:

High-precision plate for grinding and eroding



## PMNM-AL Permanent Magnetic Chuck

Super lightweight aluminum body for direct installation of clamping elements.



Model	Item-Nr.	Dimensions (mm)			corner cham-fer (mm)	Weight (kg)
		L	W	H		
PMNM-AL 2424-48	2008 2424	240	240	48	10 x 45°	18
PMNM-AL 2828-48	2008 2828	280	280	48	10 x 45°	24
PMNM-AL 3232-48	2008 3233	320	320	48	40 x 45°	26

Other dimensions on request!

## PMNM/UPC Permanent Magnetic Chuck

The PMNM UPC pallet is delivered completely ready fitted to fit the Erowa UPC clamping system with original Erowa elements. Optional with handles and/or link Gripper.



Model	Item-Nr.	Dimensions (mm)			corner cham-fer (mm)	Weight (kg)
		L	W	H		
PMNM-AL 3232-48 UPC	82008 3233	320	320	48	40	27
Gripper Link	8000 8011	-	-	-	-	-
Handles	8000 8010	-	-	-	-	-

Other dimensions on request!

## PMUNI Permanent Magnetic Chuck

Permanent PMUNI magnetic chucks have a double magnet system and a universal pole pitch. Thus the PMUNI combines the advantages of the super-strong PMNEO with the flat magnetic field of the PMNM.

The PMUNI is recommended for EDM and EDM (HSC systems) as well as for small, thin parts.



### Structure:

Double Neodym Magnetic System, Steel-body,

Transversal Pole pitch 2+1+5+1 mm

Holding power ca. 150 N/cm<sup>2</sup>

Magnetic Field Height ca. 6 mm

Pole plate wearing limit 6 mm

### Recommendation:

Strong precision plate for milling and eroding

Model	Item-Nr.	Dimensions (mm)			corner cham-fer (mm)	Weight (kg)
		L	W	H		
PMUNI 2424	2023 2424	240	240	48	10 x 45°	19
PMUNI 2828	2023 2828	280	280	48	10 x 45°	28
PMUNI 3232	2023 3232	320	320	48	10 x 45°	35
Other dimensions on request!						

The PMUNI UPC pallet is ready for the Erowa UPC Clamping system supplied with original Erowa elements. Optional with handgrips and/or Gripper Link.

Model	Item-Nr.	Dimensions (mm)			corner cham-fer (mm)	Weight (kg)
		L	W	H		
PMUNI 3232 UPC	82023 3232	320	320	48	40	36
Gripper Link	8000 8011	-	-	-	-	-
Handles	8000 8010	-	-	-	-	-
Other dimensions on request!						

## PMNEO Permanent Magnetic Chuck

Permanent magnetic chucks type PMNEO are super strong, compact plates for heavy cutting. Parts from about 30x15x6mm can be stretched with max. achievable holding forces. Good holding forces can be achieved even on rough surfaces. Optional pole blocks can be built on the PMNEO. This allows turning up the workpiece so that all sides are freely accessible, can be drilled on the magnetic clamping plate and leaves more space for accumulating chips around the component. This allows long-running HSC milling-pieces never sink into the resulting chips.

The chipboard is activated via a removable hex shifter. The PMNEO magnetic clamping plate, in 48mm height, is prepared to integrate reference elements directly into the magnetic chuck, so that no additional spectrum is required underneath the magnet.



Model	Item-Nr.	Dimensions (mm)			corner cham-fer (mm)	Weight (kg)
		L	W	H		
PMNEO 2424	2007 2424	240	240	48	10 x 45°	19
PMNEO 2828	2007 2828	280	280	48	10 x 45°	28
PMNEO 3232	2007 3234-1	320	320	48	40 x 45°	35
PMNEO 4040	2007 4040-1	400	400	48	40 x 45°	50
Other dimensions on request!						

### Structure:

Double Neodymium, Magnet system,  
Steel body,  
Transverse pole pitch 11+4 mm  
Holding power ca. 150 N/cm<sup>2</sup>  
Magnetic field height ca. 10 mm  
Pole plate wearing limit 6 mm

### Recommendation:

Super Strong plate for milling

The PMNEO UPC pallet is delivered completely ready fitted to fit the Erowa UPC clamping system with original Erowa elements. Optional with handles and/or link Gripper.

Model	Item-Nr.	Dimensions (mm)			corner cham-fer (mm)	Weight (kg)
		L	W	H		
PMNEO 3232-48 UPC	82007 3234	320	320	48	40	36
Gripper Link	8000 8011	-	-	-	-	-
Handles	8000 8010	-	-	-	-	-
102 Bushes M5	8000 8016	-	-	-	-	-
10 Pole Bars	8000 8014	100	10	14	-	-
Other dimensions on request!						

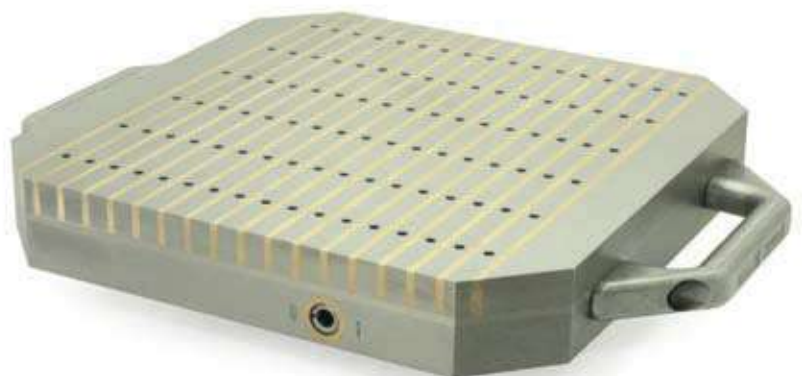

### PMNEO Permanent Magnetic Chuck

Special versions are also available with threaded inserts and additional strips. Optimal for highlighting the workpiece for machining the outer contour or to work through.



### PMNM / RS / RNF Clamping System with Erowa ITS

For use with the EROWA ITS palletizing system we recommend our PMNM Magnetic Chucks and our RNF and RS magnetic chuck. Suitable for light milling, EDM and grinding.

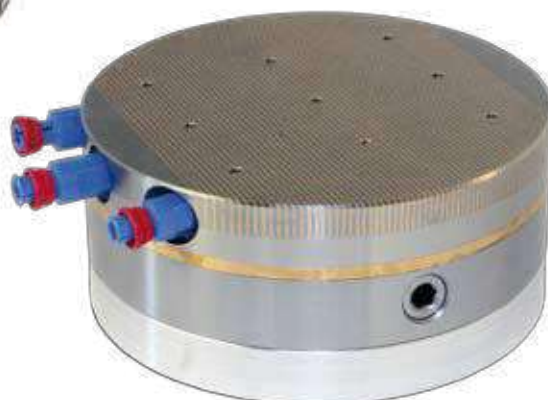

## QX-LOCK HD50 Electro-Permanent Magnetic Chucks

QX Lock magnetic chucks are equipped with extra strong frame construction. The overall height is 68 mm and the rear panels can be 22 mm deep drilled or milled 12 mm. Optimal for introducing reference elements for zero-point clamping systems. Transport thread around allows an easy horizontal or vertical crane transport.



### QX-Lock HD50 Magnetic Chucks

Model	Item-Nr.	Dimensions (mm)			Number Poles °N	Weight (kg)	Matching Control unit *
		L	W	H			
QX-Lock 402 HD50	2419 402	399	199	68	10	39	ST211 Feme
QX-Lock 404 HD50	2419 404	399	399	68	24	78	ST211 Feme
QX-Lock 406 HD50	2419 406	599	399	68	40	118	ST211 Feme
QX-Lock 408 HD50	2419 408	799	399	68	50	156	ST211 Feme
QX-Lock 410 HD50	2419 410	999	399	68	60	195	ST211 Feme
QX-Lock 505 HD50	2419 505	499	499	68	36	122	ST211 Feme
QX-Lock 506 HE50	2419 506	620	470	68	48	132	ST211 Feme
QX-Lock 508 HE50	2419 508	770	470	68	60	162	ST211 Feme
QX-Lock 510 HE50	2419 510	1040	470	68	84	282	ST211 Feme
QX-Lock 606 HE50	2419 606	620	600	68	64	172	ST211 Feme
QX-Lock 608 HE50	2419 608	780	600	68	80	212	ST211 Feme
QX-Lock 612 HD50	2419 612	1114	600	68	112	322	ST214 Feme

\* Control unit not included, Selection on Pages 99

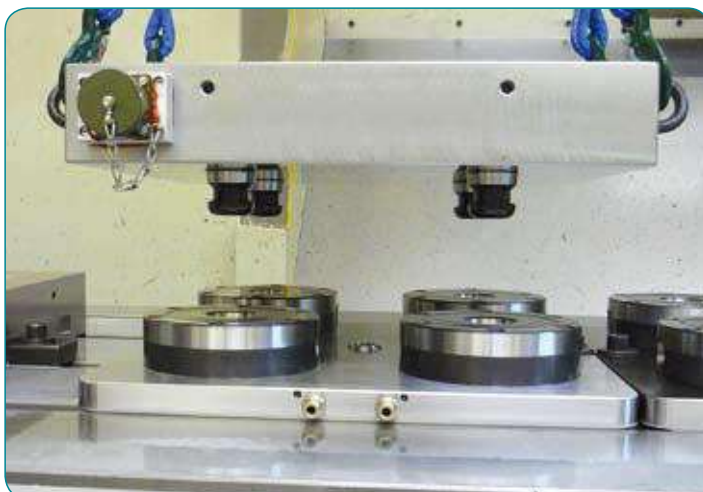

## UNILOCK®-R Zero-Point Clamping Systems

With the universal UNILOCK R zero-point clamping system, you change your workpieces and jigs made within seconds Zero oriented. The repeatability lies under 0,005mm. Reduce your machine downtime by up to 90 %!

Magnetic clamping pallets, fixtures, vises, grid plates or workpieces are provided with the UNILOCK bolt and positively to the UNILOCK zero-point clamping system, highly accurate excited and locked.



### Simple and reliable:

Unilock R spanned always and only needs to loosen a compressed air pulse. As an option the turbo input can be connected to a compressed air pulse with particularly strong chipping. This increases the pull-in force to three times.

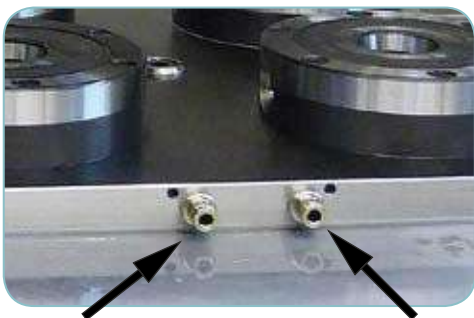

Release 6 bar      Turbo 6 bar Impuls



### Solid and Stable

The super strong universal clamping pin can be mounted in various ways to the part to clamp. The intelligent combination of bolt types A, B and C, the repeatability is achieved by < 0.005 mm.

#### mounting options UNILOCK-clamping bolt

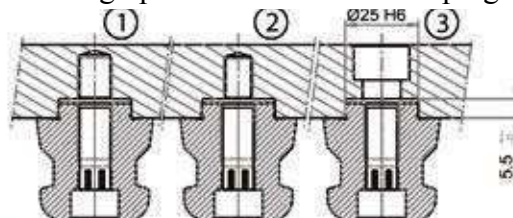

Type 1: with threaded bolt DIN 913 M12x35

Type 2: below with cylindric screw DIN 912 M10x45 (Q 12.9)

Type 3: above with cylindric screw DIN 912 M12 (Q12.9) = strongest type

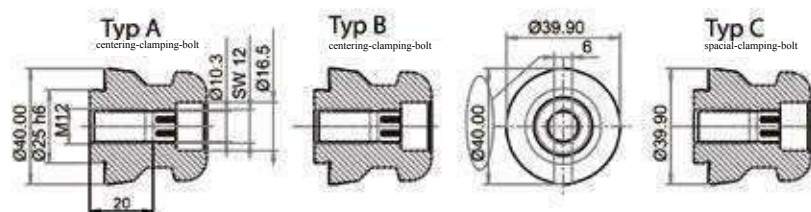

## UNILOCK®-R Zero-Point Clamping Systems

The standard pallets R2 to R10 are prepared ready for use on the machine. It can, for example, built on a R10 Unilock-palette 5 small magnetic plates, each with 2 clamp bolt as well as 2 pieces R4 UNILOCK pallets a magnetic chuck with 8 bolts are tightened.

All pneumatic connections are in the massive, polished base plate, the holes drilled in many places can be carried out. Simply screw and edit the first part after a few simple steps.



Technical features that convince:

- Repeatability < 0.005 mm
- Positive locking; Holding force 75kN
- Pneumatic system, the compressed air is used simultaneously for cleaning
- Free media , self-locking clamping system with very high Surface pressure by power transmission and locking the clamping wedges
- Compressed air supply of 6 bar to release sufficient (no hydraulics necessary)
- Massive construction of clamping modules, strongly dimensioned clamping bolt
- Large room during retraction of the clamp bolt by conical Collection of short taper
- High-precision centering in the module and at the clamping bolt
- Diverse Options to fix the clamping bolt
- Direct installation into the machine table possible

## Together we are strong!

Magnetic chucks clamp the workpiece quickly,  
Change zero point clamping systems the clamping device quickly and accurately,  
both together are the solution when it comes to productivity!

During the day, Pre-milling during the day, interrupting simple during the night, half-finished programs and take the workpiece on the machine later, accurately position move from one machine to another, tighten the set-up station and minimize machine downtime - no problem with Unilock®R + QX Lock.

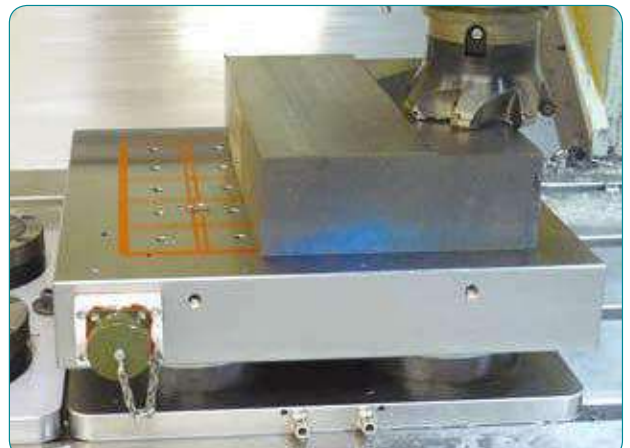

## Models and Dimensions

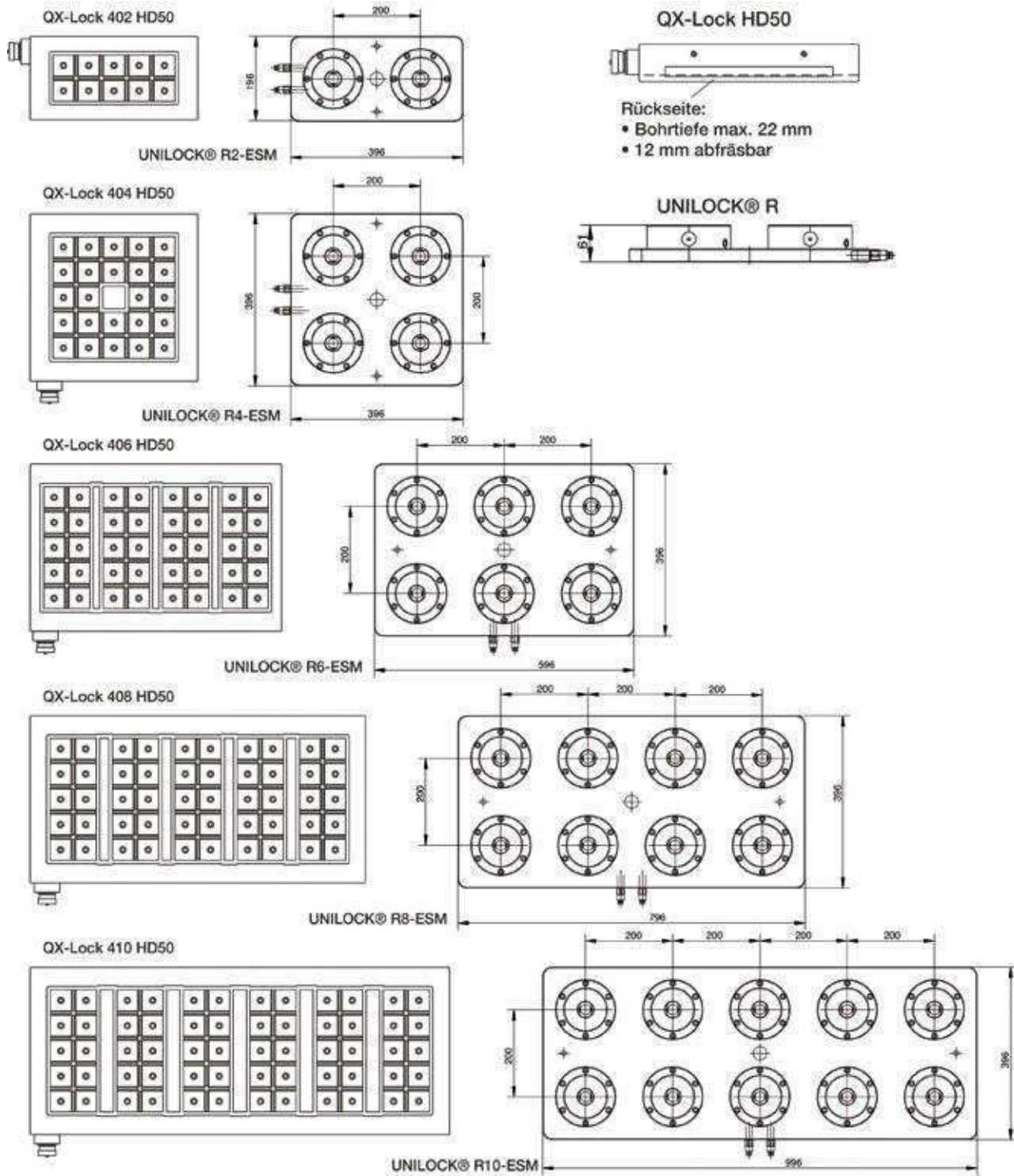

### QX-Lock Magnetic Chucks

Model	Item-Nr.	Dimension (mm)			Number Poles °N	Weight (kg)
		L	W	H		
QX-Lock 402 HD50	2419 402	399	199	68	10	39
QX-Lock 404 HD50	2419 404	399	399	68	24	78
QX-Lock 406 HD50	2419 406	599	399	68	40	118
QX-Lock 408 HD50	2419 408	799	399	68	50	156
QX-Lock 410 HD50	2419 410	999	399	68	60	195

### UNILOCK®-R Zero-point-clamping-Systems

Model	Item-Nr.	Dimension (mm)		
		L	W	H
R2 ESM	2419 4021	396	196	61
R4 ESM	2419 4041	396	396	61
R6 ESM	2419 4061	596	396	61
R8 ESM	2419 4081	796	396	61
R10 ESM	2419 4101	996	396	61



## PERMANENT MAGNETIC CIRCULAR CHUCKS

Magnetic chucks have proven their worth for grinding and turning discs, flanges and sleeves for years: Depending on the application we offer the right magnet concept

### Page 114



RM - for grinding and turning with Strong double magnet system in parallel polarity

### Page 115



RF - for grinding and turning on very thin parts with a fine double magnet system

### Page 116



RN - universal chuck in coarse pole pitch with neodymium magnet system

### Page 116



RNF - Fine pole magnet chuck with neodymium magnet system for small and thin parts

### Page 117



RS - Super strong chucks in radial poles, also suitable for hard turning

### Page 118 - 119



RSA - Super-strong chuck in radial poles and light design and fine holding force supply, also suitable for hard turning

### Page 120



TFP-C - Fine-pole electro-permanent chuck for thin workpieces

### Page 121



PFR - Radially poled electro permanent chuck for the ring processing

All magnetic chucks can be supplied with flanges according to DIN 55027/55029 or SK short cones!

## RM Permanent Magnetic Circular Chuck

Permanent Magnetic Circular Chuck Type RM, with reinforced ceramic magnet system can be used for clamping bulky and heavy workpieces. The magnetic force is infinitely variable, in the surface incorporated centering grooves facilitate alignment of the workpiece. In the rake face, a center hole can be introduced.

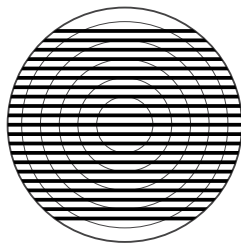
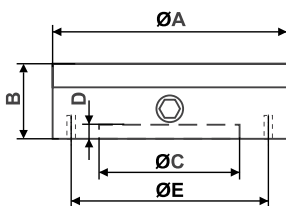
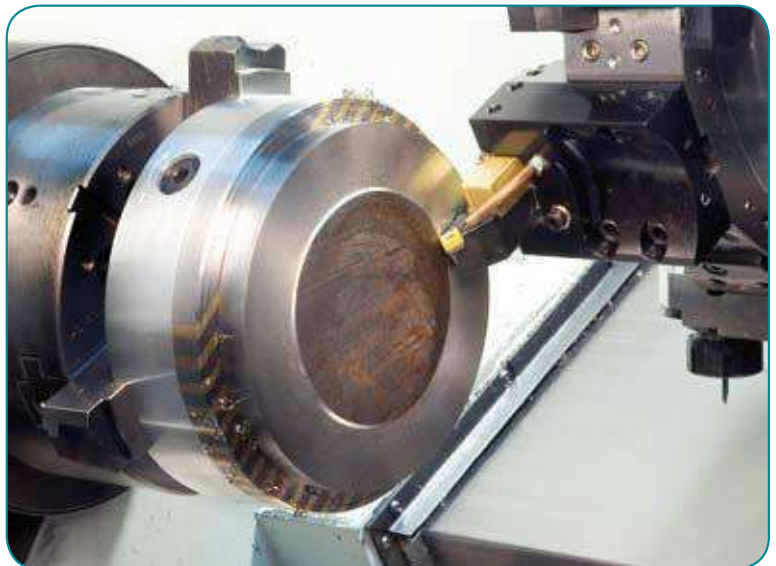

### Structure:

Ceramic Magnet system, Aluminum body,  
Max-Pole pitch 5+8 mm  
Holding power ca. 140 N/cm<sup>2</sup>  
Magnetic field height ca. 8mm  
Pole plate wearing limit 8 mm  
Switch travel MAG - ENT-MAG 500°

### Recommendation:

Super Strong round fodder for turning, also for rough parts

Model	Item-Nr.	Dimension (mm)					Holes	Pole pitch	Weight (kg)	V-Max. (U/min.)
		A	B	C	D	E				
RM 20	2101 20	200	80	150	4.5	182	4 x M8	8+5	13	800
RM 25	2101 25	250	80	200	4.5	232	4 x M8	8+5	20	700
RM 30	2101 30	300	85	250	4.5	285	4 x M8	8+5	27	700
RM 35	2101 35	350	85	300	4.4	334	4 x M8	8+5	37	600
RM 40	2101 40	400	100	300	5	350	6 x M10	8+5	56	500
RM 45	2101 45	450	100	350	5	400	6 x M10	8+5	70	450
RM 50	2101 50	500	100	400	5	450	6 x M10	8+5	90	400

## RF Permanent Magnetic Circular Chuck

Use permanent magnet type rotary feed RF, with ceramic magnet system and fine pole for clamping of thin and small workpieces, in particular for grinding and turning of thin slices and rings. The magnetic force is infinitely variable, in the surface incorporated centering grooves facilitate alignment of the workpiece. In the rake face, a center hole can be introduced.

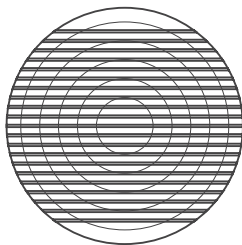
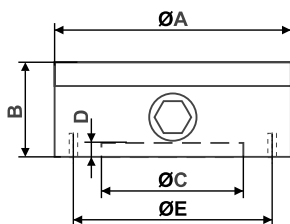

### Structure:

Ceramic Magnet system, Aluminum body,  
 Fine-pole pitch 4/6+2 mm  
 Holding power ca. 80 N/cm<sup>2</sup>  
 Magnetic field height ca. 4 mm  
 Pole plate wearing limit 8 mm  
 Switch travel MAG - ENT-MAG 500°

### Recommendation:

Precise Fine-pole-plate for thin slices

Model	Item-Nr.	Dimension (mm)					Holes	Pole pitch	Weight (kg)	V-Max. (U/min.)
		A	B	C	D	E				
RF 10	2102 10	100	62	70	2.5	91	3 x M5	4+1.5+2+1.5	3	1500
RF 13	2102 13	130	62	90	2.5	120	4 x M6	4+1.5+2+1.5	5	1200
RF 16	2102 16	160	75	125	3	142	4 x M8	6+1.5+2+1.5	8	1000
RF 20	2102 20	200	80	150	4.5	182	4 x M8	6+1.5+2+1.5	13	800
RF 25	2102 25	250	80	200	4.5	232	4 x M8	6+1.5+2+1.5	20	700
RF 30	2102 30	300	85	250	4.5	285	4 x M8	6+1.5+2+1.5	27	700

## RN Permanent Magnetic Circular Chuck

Permanent Magnetic Circular Chuck Type RN, with neodymium magnet system and low height are used for clamping of small workpieces with sufficient material thickness, especially for grinding and for assembly work. In all steel poles can be drilled 15mm deep. There may be a centering hole max. 22x5mm, or a threaded M8x12mm are introduced.

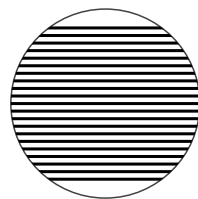
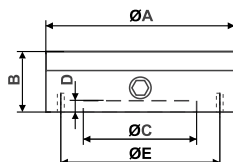

### Structure:

Neodymium Magnet system, Steel body,  
Pole pitch 8+3 mm  
Holding power ca. 80 N/cm<sup>2</sup>  
Magnetic field height ca. 6 mm  
Pole plate wearing limit 8 mm  
Switch travel MAG - ENT-MAG 180°

### Recommendation:

Strong circular chuck in flat construction

Model	Item-Nr.	Dimension (mm)					Holes	Pole pitch	Weight (kg)	V-Max. (U/min.)
		A	B	C	D	E				
RN 10	2104 10	100	50	65	2,5	86	3xM6	11+3	3	1500
RN 13	2104 13	130	50	90	2.5	120	4xM6	11+3	5	1200
RN 15	2104 15	150	50	120	2.5	120	4xM8	11+3	8	1000
RN 20	2104 20	200	50	150	2.5	182	4xM8	11+3	12	800

## RNF Permanent Magnetic Circular Chuck

Permanent Magnetic Circular Chuck Type RNF with neodymium magnet system and low height are used for clamping of small and thin workpieces.

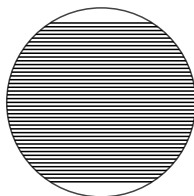
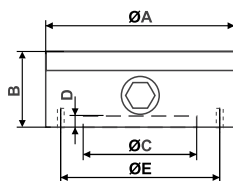

### Structure:

Neodymium Magnet system, Steel body,  
Pole pitch 1,5+0,5mm  
Holding power ca. 80 N/cm<sup>2</sup>  
Magnetic field height ca. 4mm  
Pole plate wearing limit 4 mm  
Switch travel MAG - ENT-MAG 135°

### Recommendation:

Fine-pole circular chuck for small parts

Model	Item-Nr.	Dimension (mm)					Holes	Pole pitch	Weight (kg)	V-Max. (U/min.)
		A	B	C	D	E				
RNF 8	2106 08	80	50	50	3	70	3xM5	1,5+0,5	1,8	1500
RNF 10	2106 10	100	50	60	4	85	4xM8	1,5+0,5	3	1500
RNF 13	2106 13	130	50	90	4	115	4xM8	1,5+0,5	5	1200
RNF 16	2106 16	160	50	120	4	140	4xM8	1,5+0,5	9	1000

## RS Permanent Magnetic Circular Chuck

Permanent magnet circular chuck type RS, with neodymium magnet system and radial pole pitch, used for clamping hard to holding rings and washers. Especially with large diameter, the radial or Star-pole-pitch characterized by greater rigidity and stability. RS circular chucks are specially designed for hard turning and can be operated at high speeds. The magnetic force is infinitely variable. Centering grooves facilitate alignment of the workpiece. In the center, a through hole can be introduced with the diameter C.

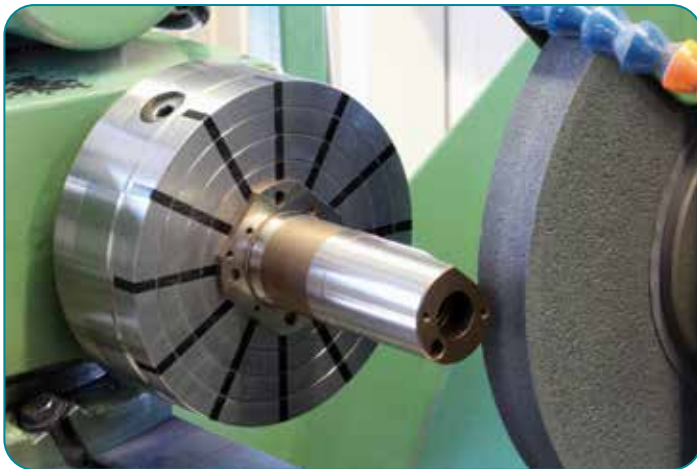

Drilling depths Polplate for new, non-ground or over-turned RS / RSA dials:

Up to  $\varnothing 400\text{mm}$  = 16mm (pole plate height 20mm ex works)

From  $\varnothing 500\text{-}600$  = 26mm (pole plate height 30mm ex works)

Do not drill in the plastic potting compound!

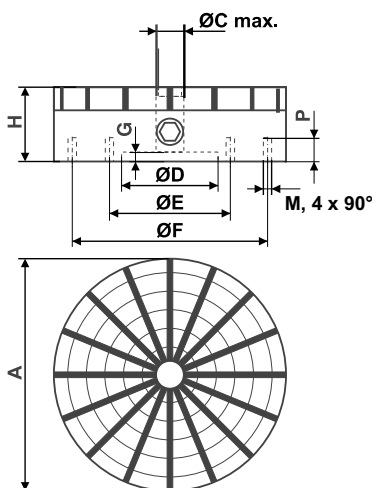

### Structure:

Neodymium Magnet system, Steel body,  
Radial-pole pitch

Holding power ca. 140 N/cm<sup>2</sup>

Magnetic field height ca. 10 mm

Pole plate wearing limit

RS 13, 3 mm, RS 15 - 80, 7 mm

Switch travel MAG - ENT-MAG 180°

### Recommendation:

Super Strong circular chuck for rings and for hard turning

Model	Item-Nr.	Dimension (mm)							Holes	Pole	Weight (kg)	V-Max. (U/min.)
		A	H	C	D	E	F	G				
RS 13	2103 13	130	57	15	50	--	100	5	M6	10	6	1000
RS 15	2103 15	150	57	23	50	80	120	5	M6	10	8	1000
RS 20	2103 20	200	57	25	60	110	180	5	M6	12	13	800
RS 25	2103 25	250	70	30	80	140	220	5	M6	16	24	700
RS 30	2103 30	300	73	38	150	180	260	6	M8	16	36	700
RS 35	2103 35	350	73	40	170	220	300	6	M8	20	48	600
RS 40	2103 40	400	75	40	200	260	340	8	M8	20	64	500
RS 50	2103 50	500	88	50	200	300	400	8	M8	24	106	400
RS 60	2103 60	600	88	90	250	350	450	8	M10	30	150	400
RS 70	2103 70	700	88	90	250	350	450	8	M10	30	234	300
RS 80	2103 80	800	110	100	350	400	700	8	M10	30	300	300

### RSA Permanent Magnetic Circular Chuck with Alu-Body

RSA magnetic chuck with aluminum base and radial pole pitch are convincing due to their lightweight design and maximum holding force.

The double neodymium magnet system is adjusted via a self-locking spindle drive and can be perfectly adjusted to the desired holding force. The RSA is a development of ours for years successful RS magnetic chuck, many of the practical experience has been incorporated into its development. Particularly when machining rings, washers and sleeves, the uniform radial pole pitch offers significant advantages according to magnetic chucks with parallel pole pitch.

In the case of the weight - critical dimensions D250-400mm the weight was compared and reduced by 25% according to the RS round chucks, the sizes 500 + 600 mm were equipped with a reinforced pole plate and a improved mechanic.



In order to release the work piece, the poles can be mounted on the radial poles, on request we offer the RSA with T notches in the poles. A through hole with a maximum diameter C can be inserted centrally, the area B is not magnetically active.





Drilling depths Polplate for new, non-ground or over-turned RS / RSA dials:  
 Up to Ø400mm = 16mm (pole plate height 20mm ex works)  
 From Ø500-600 = 26mm (pole plate height 30mm ex works)  
 Do not drill in the plastic potting compound!



Switch is included

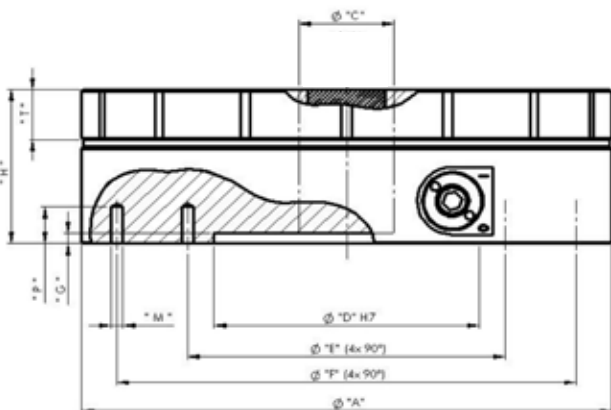

**Structure:**  
 Neodym Magnetic System, Aluminum Body,  
 Radial pole pitch  
 Holding power ca. 140 N/cm<sup>2</sup>  
 Magnetic field Height ca. 10 mm  
 Pole plate wearing limit 7mm  
 Switching travel MAG - DEMAG 500°

**Recommendation:**  
 Super-strong circular chuck especially for  
 rings and for hard turning

Model	Item-Nr.	Dimension (mm)								Holes	Pole	V-Max. (U/min.)	Weight (kg)
		A	C	D	E	F	G	H	T				
RSA 20	2105 20	200	25	60	110	180	5	79	20	M6	16	1200	12
RSA 25	2105 25	250	30	80	166	220	5	79	20	M6	16	1500	18
RSA 30	2105 30	300	38	150	180	260	6	82	20	M8	16	1200	27
RSA 35	2105 35	350	40	170	220	300	6	84	20	M8	20	1100	36
RSA 40	2105 40	400	40	200	260	340	8	84	20	M8	20	900	47
RSA 50	2105 50	500	50	200	330	400	8	109	29,5	M8	24	700	98
RSA 60	2105 60	600	90	250	350	450	8	109	29,5	M10	30	600	142

## TFP/C Electro-Permanent Magnetic Circular Chuck

TFP/C electric permanent magnet round chuck with a fine pole pitch combine the advantages of permanent and electromagnetic chucks. The particle board does not heat up during long chip times, has a very controlled magnetic field and offers the possibility of holding force control and demagnetization.

TFP / C magnetic chucks designed for grinding operations with the highest precision - even on small workpieces from 2 mm material thickness. They impress with uniform holding force over the entire gripping range. TFP / C magnetic chucks have a pole-plate-less construction. Thus, they are particularly flat, very easily and in many places machinable. The cable connection to the pole-reversal device may be laterally plugged or rear connected via a slip ring contact.

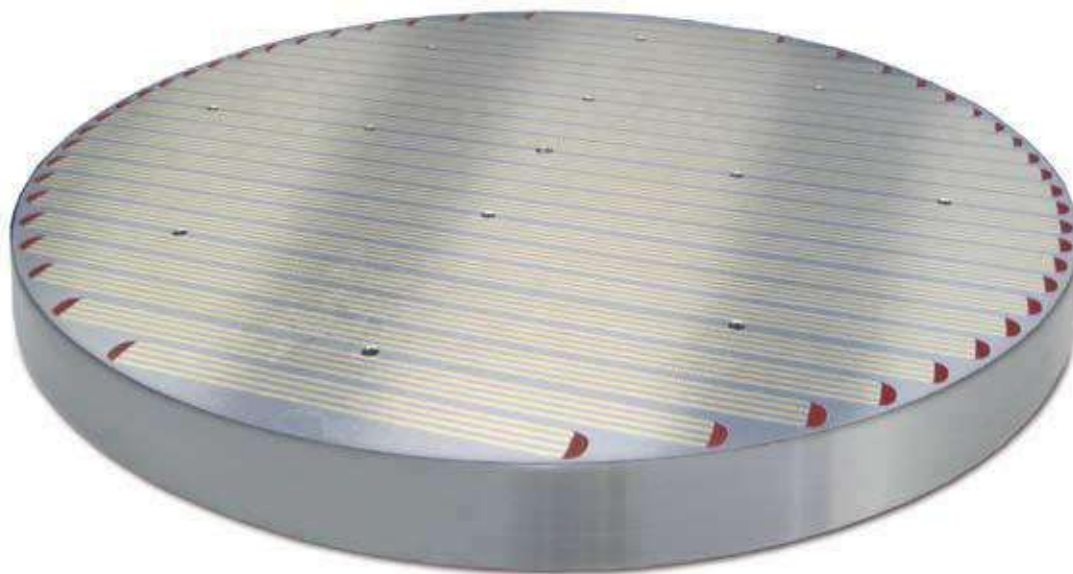

### Structure:

Electro-Permanent Magnet system,  
Steel body Mono-block  
Transversal Pole pitch 4+2+6mm with Steps.  
Holding power ca. 80 N/cm<sup>2</sup>  
Magnetic field height ca. 4 mm  
Pole plate wearing limit 5 mm  
Performance 210 V Pulse  
Protection IP 67

### Recommendation:

High-precision, slimline electro-permanent magnetic chuck for grinding thin slices and rings.

Model	Item-Nr.	Dimension (mm)		Weight (kg)
		L	B	
TFP/C 300	2722 0300	300	54	28
TFP/C 400	2722 0400	400	54	52
TFP/C 500	2722 0500	500	54	80
TFP/C 600	2722 0600	600	54	120

Matching pole-reversal devices Type ST211 GR on Page 99.



## PFR Electro-Permanent Magnetic Circular Chuck

PFR magnetic chuck suitable for final processing of rings and for hard turning or grinding. The reinforced ceramic magnet system also allows to fully demagnetize high-alloy and hardened materials after processing. The monoblock base body and the brass isolated magnetic poles ensure maximum rigidity and best heat dissipation. Optional deployable mobile and flexible pole extensions allow to span the workpiece indemnify and non-warping.

Diameter up to 2000mm are manufactured massively from a base body. Larger diameters can be composed of individual segments. The cable connection to the pole-reversal device may be laterally plugged or rear connected via a slip ring contact.



**Structure:**  
 Electro-Permanent Magnet system,  
 Steel body + Pole-plate  
 Radial Pole pitch  
 Holding power ca. 100 N/cm<sup>2</sup>  
 Pole plate wearing limit 6 mm  
 Performance 400 V Pulse  
 Protection: IP 67

Model	Item-Nr.	Dimension (mm)			Poles	Weight (kg)
		ØD1	ØD2	H		
PFR 060030	2503 0603	600	300	110	12	180
PFR 080030	2503 0803	800	300	110	12	330
PFR 100030	2503 1003	1000	300	110	20+10	500
PFR 125030	2503 1203	1250	300	110	20+10	800
PFR 125050	2503 1205	1250	500	110	20	800
PFR 150050	2503 1505	1500	500	110	20	1100
PFR 200100	2503 2010	2000	1000	110	32	1700

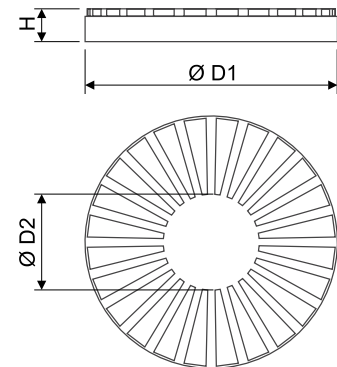

Matching pole-reversal devices Type ST211 GR on Page 99.

## LAMELLA PLATES

Lamella plates and beams are used in conjunction with magnetic clamping plates. If parts can be clamped on a magnetic chuck very difficult or impossible because of very low material thickness, three-dimensional structure or poor magnetic properties, Lamella plates offer several additional opportunities. In lamella plates pins can be used and contours are incorporated, or to use them, for example, T-shaped parts as bearing surfaces. Lamella plates be hung up or screwed onto the magnetic chuck. Our sheets are, unless stated otherwise, silver-hard-soldered and can be machined to any type.

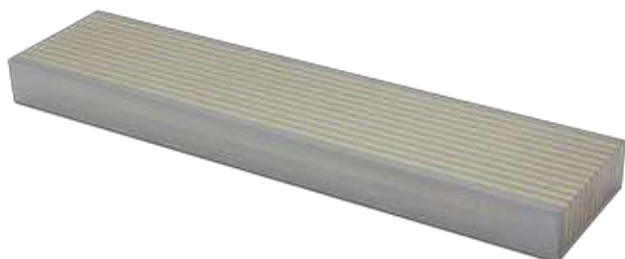

Lamella plates in longitudinal section,  
silver brazed Pole pitch 3+1mm

Item.-Nr.	Dimension (mm)		
	L	B	H
2303 320 075	320	75	25
2303 320 100	320	100	25
2303 320 200	320	200	25
2303 650 075	650	75	25
2303 650 100	650	100	25
2303 650 200	650	200	25

The length can be shortened as desired  
Ratio L / min. 1.5xB

Lamella plates in transversal pole pitch  
silver brazed Pole pitch 3+1mm

Item.-Nr.	Dimension (mm)		
	L	B	H
2302 100 075	100	75	25
2302 200 075	200	75	25
2302 200 100	200	100	25
2302 200 150	200	150	25

The above articles are stock items

### Comment

Larger dimensions, thickness 40mm and other pole pitch is possible after consultation. Special dimensions are not silver brazed but glued and screwed available!

## LAMELLA BLOCKS

Lamella blocks in pole pitch 1,5 + 3 , screwed, can not be shortened.



Item-Nr.	Dimension (mm)		
	L	B	H
2304 101	60	80	30
2304 102	80	100	40
2304 103	100	140	50

## LAMELLA PLATES round

Round Lamella plates, silver brazed.



Item-Nr.	Dimension (mm)	
	L	B
2305 100	100	25
2305 130	130	25
2305 150	150	25
2305 200	200	25
2305 250	250	25
2305 300	300	25

Other dimensions on request!

## LAMELLA PLATES round radial

Round Plates for Radial-pole Chucks



Item-Nr.	Dimension (mm)		Number of Poles
	L	B	
2306 130-1	130	20	10
2306 150-1	150	20	10
2306 200-1	200	20	12
2306 250-1	250	20	16
2306 300-1	300	20	16
2306 350-1	350	20	20
2306 400-1	400	20	20
2306 500-1	500	20	24
2306 600-1	600	20	30

Other dimensions on request!

Angel-Blocks and Prisms on request!

## SPM Permanent Magnetic Blocks

SPM magnetic clamping blocks have 4 clamping sides and can be switched via the front panel rotary knob. They can be used for surface grinding, angle-grinding, coordinate grinding, eroding, measuring, etc. Because of the fine 2 + 2 mm pole pitch (0.5 mm) thinnest parts can securely be clamped. On the back there are four M5 threaded for mounting stops. The low magnetic field height of only 2mm and the complete hermetic seal to recommend SPM clamping blocks especially for use in wire and die-sinking EDM. SPM clamping blocks are also available in stainless chrome steel design.



Model	Item-Nr.	Dimension (mm)			clamping areas 4 St., (mm)	Pole pitch (mm)	Holding power (N/cm <sup>2</sup> )	Weight (kg)
		L	B	H				
SPM	2301 01	175	64	64	115 x 64	2 + 2	80	3,2
SPM-L	2301 02	195	64	64	135 x 64	2 + 2	80	3,8
SPM-X	2301 03	175	64	64	115 x 64	2 + 2	50	3,2
SPML-X	2301 04	195	64	64	135 x 64	2 + 2	50	3,8

-X = Stainless version made of chrome steel • Be careful when sanding, less holding force

## SPMQ Permanent Magnetic Blocks

SPMQ permanent magnetic clamping blocks have 3 clamping sides (top, left and right side surface) and can be switched via the front panel. On the top there is a cross prism. Main areas of application can be found in the grinding and measuring. Angularity 0.025mm, 0.015mm parallelism.

Model	Item-Nr.	Dimension (mm)			Holding power (N/cm <sup>2</sup> )	Weight (kg)
		L	W	H		
SPMQ 1	2303 01	100	100	100	80	6
SPMQ 2	2303 02	150	150	150	80	24
SPMQ 3	2303 03	180	180	180	80	41



## SPML Permanent Magnetic Clamping Blocks

SPML permanent magnetic clamping blocks are equipped with two opposed, independently switchable clamping surfaces. The neodymium magnet system with fine pole 1.5 +0.5 affects about 5 mm deep and is ideal for clamping small and medium sized workpieces. The switching shaft can be actuated from two sides, so that the magnetic clamping block may also be used standing. Two M5 threads are located on the sides of the head on which stops or positioning can be attached. SPML clamping blocks are watertight and especially suitable for grinding, wire and sinker EDM. For use in aggressive media we recommend INOX.

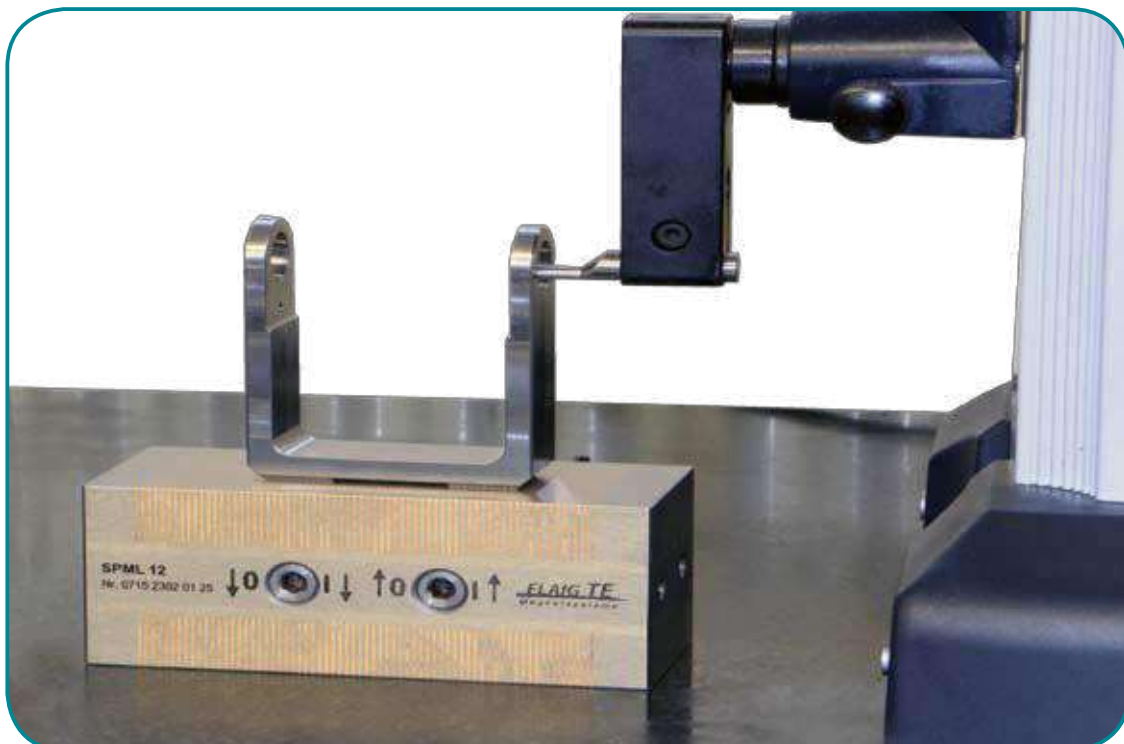

# Magnetic Clamping

Model	Item-Nr.	Dimension (mm)			Pole pitch (mm)	Holding power (N/cm <sup>2</sup> )	Weight (kg)
		L	W	H			
SPML 12	2302 01	125	52	50	1,5 + 0,5	80	2,5
SPML 12 Pair / jointly ground	2302 01-1	125	52	50	1,5 + 0,5	80	2x2,5
SPML 18	2302 02	180	52	50	1,5 + 0,5	80	3,6
SPML 18 Pair / jointly ground	2302 02-1	180	52	50	1,5 + 0,5	80	2x3,6
SPML 25	2302 03	250	52	50	1,5 + 0,5	80	5
SPML 25 Pair / jointly ground	2302 03-1	250	52	50	1,5 + 0,5	80	2x5

**Structure:**  
Neodym Magnetic System, Steel with best Magnetic flux properties  
2 separate switchable clamping surfaces  
Transversal pole pitch 1,5+0,5  
Holding power ca. 80 N/cm<sup>2</sup>  
Magnetic Field Height ca. 5mm  
Pole plate wearing Limit ca. 3mm

**Recommendation:** Precise, strong Clamping Block for grinding, measuring and eroding.

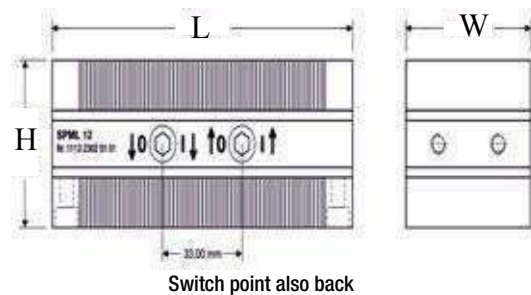

**For use in aggressive media, we recommend INOX**

Model	Item-Nr.	Dimension (mm)			Pole pitch (mm)	Holding power (N/cm <sup>2</sup> )	Weight (kg)
		L	W	H			
SPML 12 INOX	2302 06	125	52	50	1,5 + 0,5	60	2,5
SPML 12 INOX Pair / jointly ground	2302 06-1	125	52	50	1,5 + 0,5	60	2x2,5
SPML 18 INOX	2302 07	180	52	50	1,5 + 0,5	60	3,6
SPML 18 INOX Pair / jointly ground	2302 07-1	180	52	50	1,5 + 0,5	60	2x3,6
SPML 25 INOX	2302 08	250	52	50	1,5 + 0,5	60	5
SPML 25 INOX Pair / jointly ground	2302 08-1	250	52	50	1,5 + 0,5	60	2x5

**Structure:**  
Neodym Magnetic system, stainless Steel  
2 separate switchable clamping surfaces  
Transversal pole pitch 1,5+0,5  
Holding power ca. 60 N/cm<sup>2</sup>  
Magnetic Field Height ca. 5mm  
Pole plate wearing Limit ca. 3mm

**Recommendation:**  
Precise, stainless Clamping Block for grinding, measuring, eroding and wire cutting

## MH Permanent Magnetic Blocks

MH permanent magnetic clamping blocks have 2 or 3 magnetic clamping surfaces that are not switchable. They are used for clamp the finest parts or poorly magnetizable materials such as high-alloy chromium steels or carbide. After editing, the block and the clamped workpiece can be taken completely for inspection of the machine. MH clamping blocks are available in a standard or reinforced (with SE - magnet). Main areas of application can be found at the grinding, measuring, wire cutting.

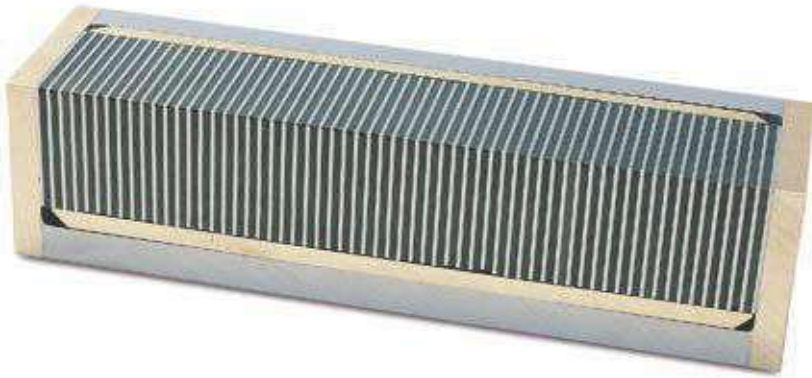

Standard version ca. 100 N/cm<sup>2</sup>

Model	Item-Nr.	Dimension (mm)			Pole pitch (mm)	holding areas	Weight (kg)
		L	W	H			
MH 1	2306 01	100	100	50	4	3	3,2
MH 2	2306 02	100	50	50	4	3	1,6
MH 3	2306 03	100	25	25	4	2	0,4
MH 4*	2306 04	100	25	25	1,3	2	0,4

\* especially suitable for thin pieces



Reinforced version ca. 180 N/cm<sup>2</sup>

Model	Item-Nr.	Dimension (mm)			Pole pitch (mm)	holding areas	Weight (kg)
		L	W	H			
MHS 1	2306 11	100	100	50	4	3	3,2
MHS 2	2306 12	100	50	50	4	3	1,6
MHS 3	2306 13	100	25	25	4	2	0,4
MHS 4	2306 14	100	80	20	5,5	1	1,3
MHS 5	2306 15	120	80	20	5,5	1	1,5
MHS 6	2306 16	150	80	20	5,5	1	2,4
MHS 7	2306 17	180	80	20	5,5	1	2,6
MHS 8*	2306 18	200	80	22	11,5	1	2,8
MHS 9*	2306 19	325	165	22	11,5	1	8,5
MHS 10	2306 20	230	230	24	11,5	1	10
MHS 11	2306 21	250	240	24	11,5	1	11
MHS 12	2306 22	350	340	24	11,5	1	22

\* Version with 2 Stop bars

### MPX Magnetic prisms made of tool steel / hardened

MPX magnetic prisms operate with a super-strong neodymium magnet system.

MPX have 3 clamping surfaces, both the back and both prisms are magnetically active. This makes it possible to position workpieces horizontally or vertically and to simultaneously clamp the prism on a metallic base. The activation is carried out using the included 8mm Allen key in only 90° rotation.

When measuring, grinding, eroding and assembling, magnetic prisms also find their application directly on the magnetic clamping plate of the grinding machine without losing magnetic force.



MPX magnetic prisms are made of high precision  
Tool steel  
Phosphated, gas nitrided and waterproof  
Angularity and parallelism + -0.01 / 100  
Hardness 570 HV / 53 HRC  
Holding force - reinforced  
Also available in stainless steel version!  
MPX magnetic prisms are available in 3 different sizes

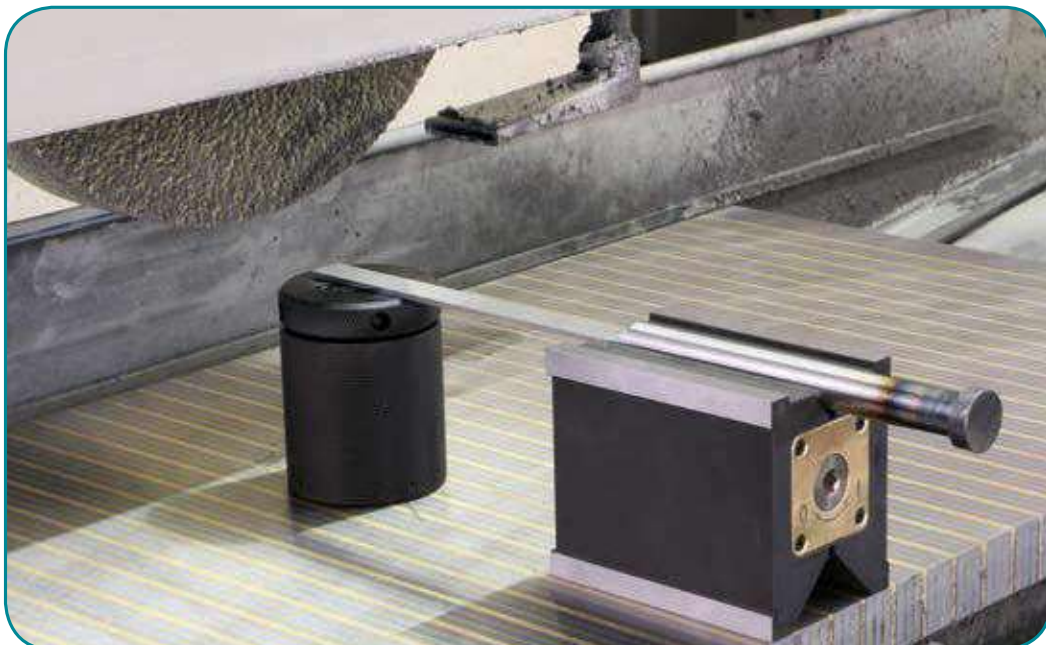

Also suitable for use on the grinding machine





Precise measurement of workpieces



Available singly or as a pair

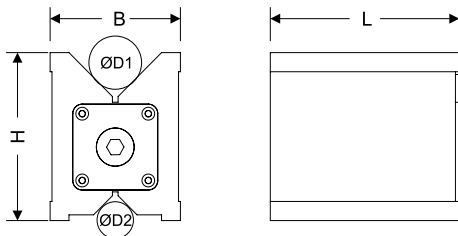

Model	Item-Nr.	Dimensions (mm)			Clampable Ø D1(mm)	Clampable Ø D2(mm)	Weight (kg)
		L	B	H			
MPX 75	230 751	75	69	88	4-65	4-28	2,9
MPX 75 Pair / jointly ground	230 751-1	75	69	88	4-65	4-28	2x2,9
MPX 100	230 752	100	69	88	4-65	4-28	3,9
MPX 100 Pair / jointly ground	230 752-1	100	69	88	4-65	4-28	2x3,9
MPX 125	230 753	125	69	88	4-65	4-28	4,8
MPX 125 Pair / jointly ground	230 753-1	125	69	88	4-65	4-28	2x4,8

Switch key included

Model	Item-Nr.	Dimensions (mm)			Clampable Ø D1(mm)	Clampable Ø D2(mm)	Weight (kg)
		L	B	H			
MPX 75 INOX	230 754	75	69	88	4-65	4-28	2,9
MPX 75 INOX Pair / jointly ground	230 754-1	75	69	88	4-65	4-28	2x2,9
MPX 100 INOX	230 755	100	69	88	4-65	4-28	3,9
MPX 100 INOX Pair / jointly ground	230 755-1	100	69	88	4-65	4-28	2x3,9
MPX 125 INOX	230 756	125	69	88	4-65	4-28	4,8
MPX 125 INOX Pair / jointly ground	230 756-1	125	69	88	4-65	4-28	2x4,8

Switch key included

## ECB Permanent Magnetic Blocks

ECB Permanent magnetic clamping blocks have a 2-pin chip surface, which is activated or deactivated via the front operating toggle. They are designed for milling and can be used very flexibly. On the clamping side soft pole strips are placed, which can also be turned on and reworked. So specially shaped magnetic poles can be constructed, for example, difficult to clamp workpieces. Likewise, different clamping heights can be realized for stepped workpieces. The material thickness of the clamped parts should not be significantly below 20 mm. Around the magnetic clamping block several holes for attaching additional attacks are introduced. ECB magnetic clamping blocks on both sides have a switch-shaft outlet, several ECB can be operated jointly via an adapter. Angularity 0.015/100mm, parallelism 0.01/100mm.

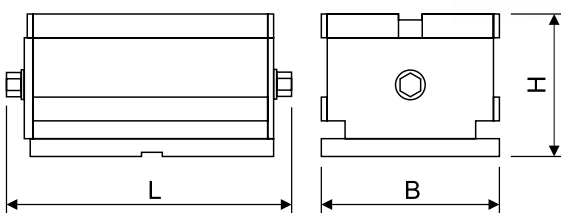

Model	Item-Nr.	Dimension (mm)			clamping area (mm)	Holding force (kN)	Weight (kg)
		L	W	H			
ECB 50+	2308 04	175	76	61	126 x 76	5	7
ECB 75+	2308 06	222,5	76	88	174 x 76	7,5	9,5
ECB 120+	2308 08	235	108	94,5	188 x 108	12	18
ECB 210+	2308 02	272	133	115	234 x 133	21	36

## Magnetic Systems in Special Versions

The normal standard is often not enough for countless different applications. But also for this our professionals have the necessary experience and the know-how. Please tell us your specific application and together we will find the suitable magnetic solution for you!

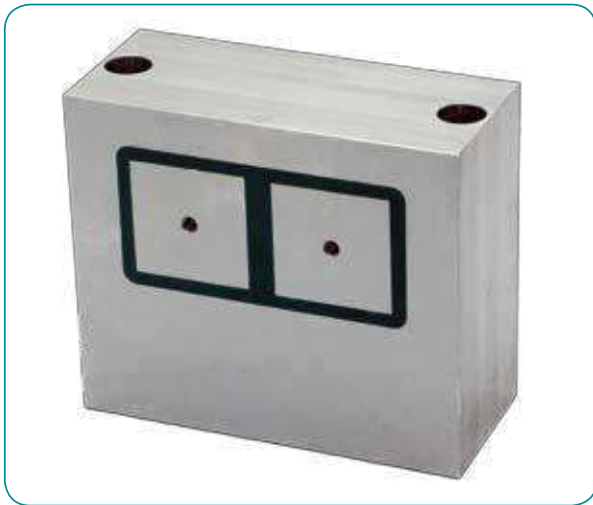

## MAGNETIC TOOLS

Magnetic tools are available for many work areas. Particularly in sheet metal processing and welding are vital helpers.

With magnets can be positioned metal parts, held lifted, separated, together or even how our GRM-XL terrain cleaning magnet, collected.

In addition to our wide range of tools for different applications we are happy to cater to your specific needs.

**Page 133 - 134**



Magnetic Clamping Balls

**Page 137**



Double-sided Clamping Blocks

**Page 138**



Magnetic fluxes, magnet bases and  
Magnetic articulation stands

**Page 139 - 141**



Rail cleaning magnets and magnetic  
cleaning machines

**Page 142**

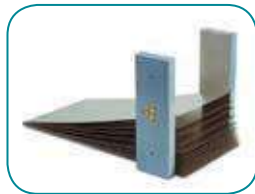

Plate spreading magnets

**Page 143 - 144**



Protective magnets, magnetic filters and  
rods

**Page 145 - 146**



Magnetic Welding and Assembly Aids

**Page 147 - 150**



Sub-band and flame magnets

## ERGO-BALL Magnetic Clamping Ball

ERGO-BALL magnetic clamping balls of the highest quality are used to hold parts during laser welding, polishing and assembly in optimum working position. Depending on the workpiece geometry and weight swing angle can be adjusted up to 90°. The strong RNF magnetic chuck is activated T-handle wrench on the hexagon supplied.

With a rotation of 120° of the key the magnetic chuck is fully activated. For positioning of the workpiece, a partial activation is possible.

The quality ERGO-BALL is made of anodized Aluminum-ball, in which a fine pin RNF magnetic chuck is installed. The ball lies in a leather lined, chemically nickel-plated steel ring. The ERGO-BALL is available in 4 sizes, with round magnet chucks of 80-160mm diameter. Quality „Made in Germany“ for ergonomic, high-quality work.



## ERGO-BALL Magnetic Clamping Ball

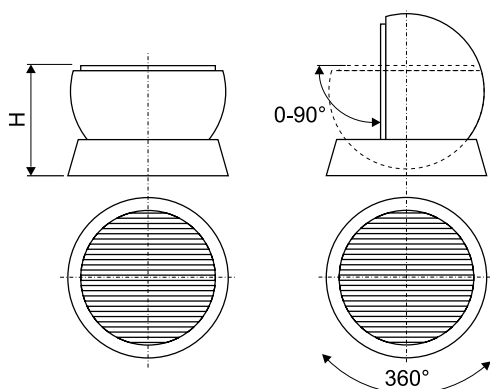

Model	Item-Nr.	Magnetic circular chuck			Clamping Ball Ø (mm)	Height H (mm) at 0°	Weight Ball (kg)	Weight Holding ring (kg)	Colors available
		Ø (mm)	Holding power N/cm <sup>2</sup>	Pole pitch					
ERGO-BALL 80 si	3001 008-1	80	80	1,5+0,5 mm	128	104	4	1	✓
ERGO-BALL 80 sw	3001 008-2	80	80	1,5+0,5 mm	128	104	4	1	a.A.
ERGO-BALL 80 bl	3001 008-3	80	80	1,5+0,5 mm	128	104	4	1	a.A.
ERGO-BALL 100 si	3001 010-1	100	100	1,5+0,5 mm	158	129	7	2	✓
ERGO-BALL 100 sw	3001 010-2	100	100	1,5+0,5 mm	158	129	7	2	a.A.
ERGO-BALL 100 bl	3001 010-3	100	100	1,5+0,5 mm	158	129	7	2	a.A.
ERGO-BALL 130 si	3001 013-1	130	100	1,5+0,5 mm	188	145	11	4	✓
ERGO-BALL 130 sw	3001 013-2	130	100	1,5+0,5 mm	188	145	11	4	a.A.
ERGO-BALL 130 bl	3001 013-3	130	100	1,5+0,5 mm	188	145	11	4	a.A.
ERGO-BALL 160 si	3001 016-1	160	100	1,5+0,5 mm	218	164	17	5	✓
ERGO-BALL 160 sw	3001 016-2	160	100	1,5+0,5 mm	218	164	17	5	a.A.
ERGO-BALL 160 bl	3001 016-3	160	100	1,5+0,5 mm	218	164	17	5	a.A.

## Accessories

Precision Vices, as an accessory to the ERGO-BALL Magnetic clamping ball, allows to span and fix non-magnetic parts edgewise. The jaws are equipped with double prism.

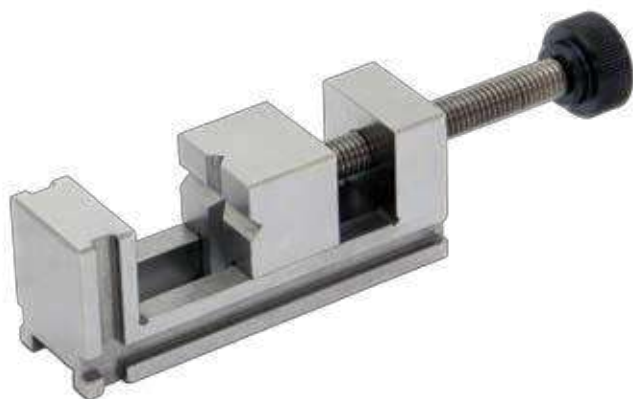

Model	Item-Nr.	Dimensions (mm)				Weight (kg)
		Width	Length	Height	Span	
PS 30	9090 3040100	30	100	40	45	0,560

## FLEX-BALL Magnetic Clamping Ball

FLEX-BALL is a switchable permanent magnet for flexible clamping of magnetic workpieces and is suitable for use on milling machines, grinders and particularly to laser welding systems. In any rotating and swiveling ball receiving a switchable permanent magnet is mounted, which serves for clamping of the workpiece. This ball receiving is stored in a switchable permanent magnet shell. This patented arrangement allows hitherto unrealizable degrees of freedom. So angles  $>90^\circ$  can also be adjusted and securely fixed. Owing to limited angle workpiece weights can be spanned up to 100kg. For clamping of the non-magnetic workpieces, a vice or a jaw chuck also can be clamped on the magnetic chuck.

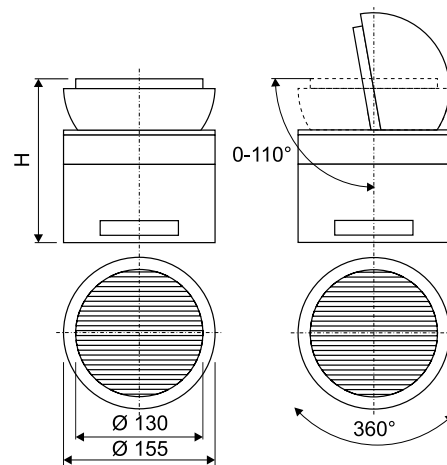

Model	Item-Nr.	Diameter clamping magnet (mm)	Diameter clamping Ball (mm)	Height (mm)	Holding power N/cm <sup>2</sup>	Weight (kg)
Flex-Ball	3001 130	130	155	175 (bei 0°)	80	12
Other dimensions available on request Supplied with 2 clamping claws and a 6-square-switching key.						

## DS 300 Polishing Table

Workpieces up to 200kg can be spanned to the DS 300 clamping table, swing in the range between  $0^\circ$  and  $100^\circ$  and rotate on the turntable by  $360^\circ$ . The rotation lock and the swivel drive with self-locking ensure a secure hold of the workpiece in any working position. The built RM 30 magnet round lining keeps small and large parts safely.



Model	Item-Nr.	Ground plate (mm)	Height turntable (mm)	Turntable Ø (mm)	Weight (kg)
DS 300	3001 300	540 x 420	130	300	65

## MBX Magnetic Clamping Blocks

MBX magnetic clamping blocks have opposite clamping sides which are activated when actuated. They are designed to clamp workpieces on steel surfaces such as machine or assembly tables.

A number of MBXs can also be connected to each other via the hexagonal shank of the switching shaft in order to clamp longer or larger workpieces.

The activation is effected via the detachable switch wrench with only 90° switching travel, the surfaces of the MBX are completely nickel-plated.

With the two differently shaped clamping sides of the MBX almost any workpiece geometry can be held, regardless of whether round material, sheets or even profiles are to be clamped.



The MBX magnetic clamping block clamps itself on the table and tension the workpiece

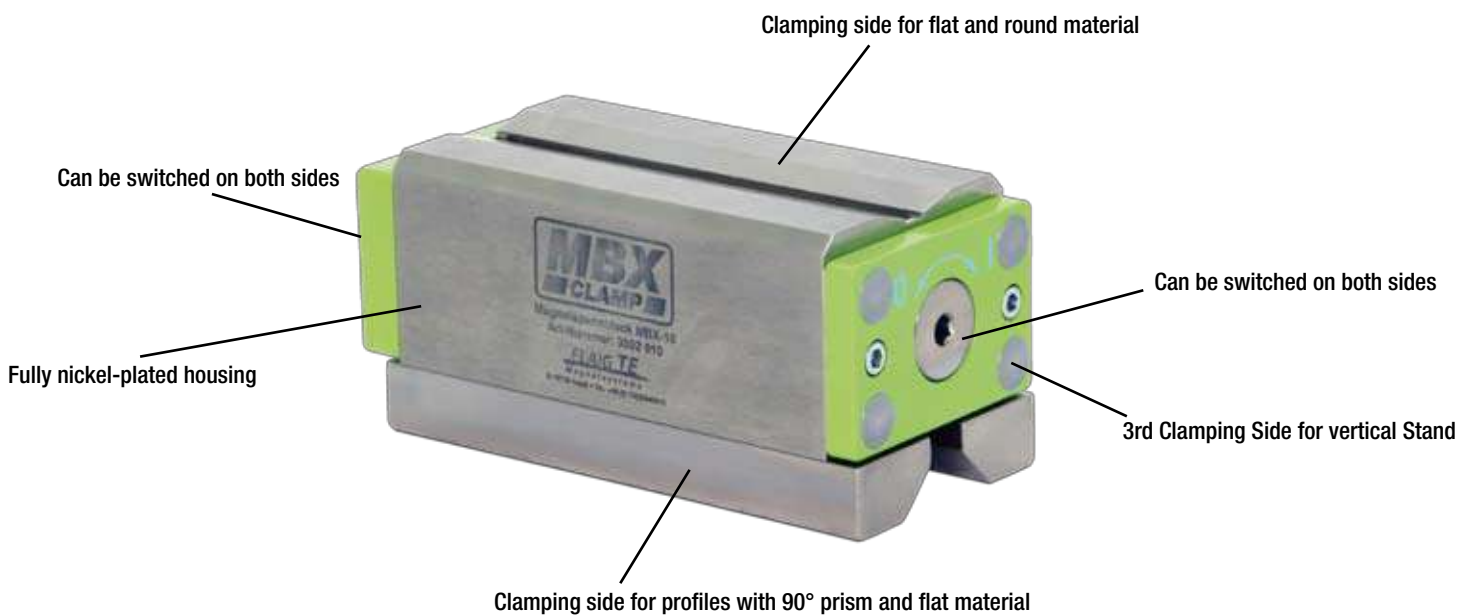



MBX are the optimal clamping tool for welding, deburring or welding Tapping quickly, flexibly and without stress.



Suitable for drilling, grinding, welding ... even vertical!



Suitable for angle material



Suitable for Round material



Suitable for Flat material



Tip: The 90° poles of the MBX can be replaced with workpiece-specific poles



Tip: Multiple MBX can be switched at the same time

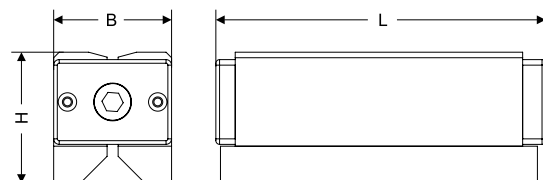

Model	Item-Nr.	Dimension (mm)			Surface 1 (mm) (Flat + Round)	Surface 2 (mm) (Flat + 90°)	System holding Power (kN)	Weight (kg)
		L	B	H				
MBX 5	3002 005	143	64	71	120 x 57	136 x 64	5	3,9
MBX 5 Pair	3002 005-1	143	64	71	120 x 57	136 x 64	5	2x3,9
MBX 7	3002 007	178	64	71	156 x 57	172 x 64	7	4,9
MBX 7 Pair	3002 007-1	178	64	71	156 x 57	172 x 64	7	2x4,9
MBX 10	3002 010	184	87	88	162 x 76	178 x 87	10	8,8
MBX 10 Pair	3002 010-1	184	87	88	162 x 76	178 x 87	10	2x8,8

## MB Switchable Magnetic Bases

MB magnetic bases are switchable via the front panel knobs. Standard holes are present, additional holes can be introduced. MB magnetic bases use, refer to the fixture, as scaffold, for quick setting of stops, as a welding aid, etc.



Model	Item-Nr.	Dimensions (mm)			tested Holding power (kN)	drilling	Weight (kg)
		L	W	H			
MB 35	3002 035	35	30	35	0,25	1 x M8	0,2
MB 50	3002 050	50	50	50	0,6	1 x M8	0,8
MB 120	3002 120	120	50	50	1,5	2 x M5	2

## SH Magnetic joint Tripods

Magnetic joint tripods type SH in robust and stable construction have a 4-piece articulated boom with hydraulic central clamping. The fine adjustment via a knurled screw. The magnetic base can be switched with a prism sole for flat and round seating surfaces.



Model	Item-Nr.	Total height (mm)	Length Arm (mm)	Magnetic base L x W x H (mm)	Weight (kg)
SH 260	3003 260	310	260	60 x 50 x 55	1,5
SH 300	3003 300	360	300	60 x 50 x 55	1,8
SH 400	3003 400	480	400	75 x 50 x 55	2,2

## GRM-XL Terrain cleaning Magnet

The terrain cleaning magnets GRM-XL are used to clean open-air site, traffic areas and large-scale industrial buildings from metal parts lying around. Take dangerous items such as shavings, nails, screws, stamping parts and so on, thus protecting your employees and vehicles.



GRM-XL magnets are made of a super strong neodymium magnet system, which is built, extremely stable, in a steel case with stainless steel base plate. They are simply added to the forklift fork and out across the floor. The taken parts can then be resolved from the magnet by moving the shift lever. So metal waste can be dropped directly on a container or tank.

- Catch height nails 3x80mm = 175mm
- Recommended ground clearance in use 80-110mm
- Recommended speed 1m/sec
- Special sizes also available on request

Model	Item-Nr.	Working width (mm)	Weight (kg)
GRM-XL 1200	3004 9127	1270	220
GRM-XL 1800	3004 9187	1870	265

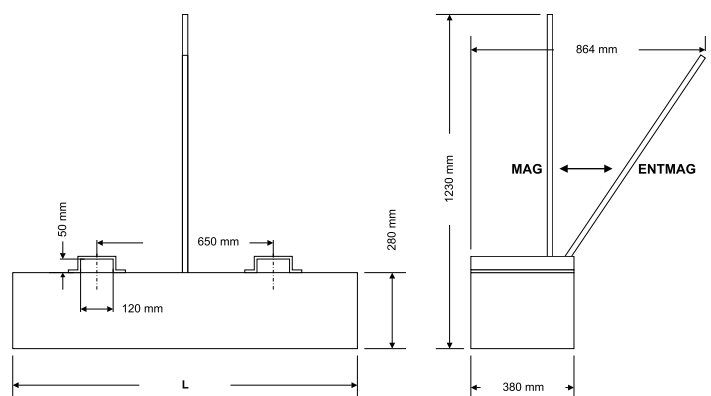

## GRM-INOX Terrain cleaning Magnet

The terrain cleaning magnets GRM-INOX are used to free terrain, traffic areas and large-scale industrial buildings from metal parts lying around. Take dangerous items such as shavings, nails, screws, etc., and thus protect your employees and vehicles. They can be grown as a permanent magnet fixed to the Forklift. So your areas are cleaned continuously. The device is waterproof to 100% and can even be used for underwater-cleaning.



GRM-INOX magnets are made of a super strong neodymium magnet system, built extremely stable into a stainless steel housing. They are simply added to the forklift fork and out across the floor. The length of the cleaning magnet is tailored to your requirements and can be freely defined for each application.

- Catch height nails 3x80mm = 140mm
- Recommended ground clearance in use 60mm
- Recommended speed 1m/sec

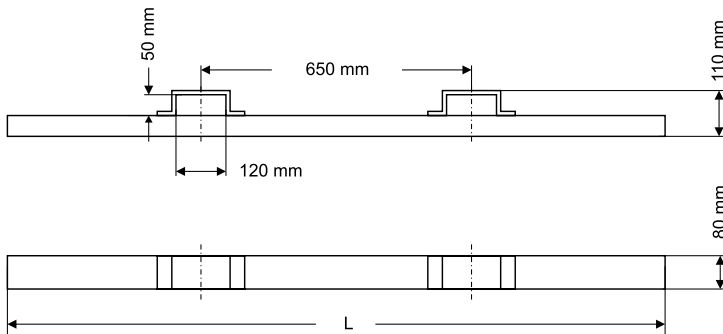

Model	Item-Nr.	Working width (mm)	Weight (kg)
GRM-INOX 1200	3004 1200	1200	36
GRM-INOX 1500	3004 1500	1500	45
GRM-INOX 2000	3004 2000	2000	65

GRM-INOX works with ND-high-energy magnets. This satisfies a work surface of 80 mm, which can be easily cleaned by hand.



## KMF Permanent Magnetic Sweepers

KMF magnetic sweepers are used to collect chips, nails, stampings and other ferromagnetic small parts, which are usually bad to sweep or absorb. The permanent magnet system with extremely low magnetic field is located in a mobile, stable housing made of stainless steel sheet. The wheels are not laterally but arranged behind the housing, which means, Corners can be fully cleaned. The height-adjustable wheels can also be adjusted uneven terrain. All housing parts are made of stainless steel, the machine is maintenance-free and also suitable for outdoor work. Via the pedal, the magnetic field is switched off and the collected particles fall down from the machine. These devices are used in metal processing plants, on construction sites and in recycling.

Model	Item-Nr.	Working width (mm)	Weight (kg)
KMF 600	3004 600	610	24

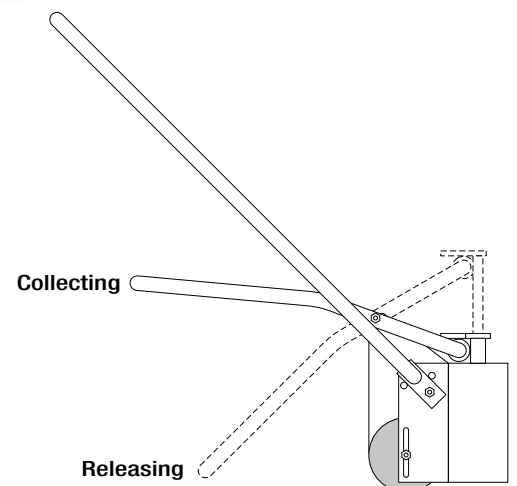

## SPREADING MAGNETS

Plate-spreading-magnets are used for separating of stacked iron and steel sheets. The sheet separators are laterally grown from the sheet stack, they magnetize the sheets with the same poles, which repel them from each other. Plate-spreading-magnets apply both in automated systems where plates with vacuum or transshipped are magnetic, and the manual work, where the gripping sheet is greatly facilitated by their help. Our Plate-spreading-magnets consist of a reinforced magnet system, which is installed in a stable sheet steel housing. The front panel is made of stainless steel. On the rear side, mounting holes are introduced.

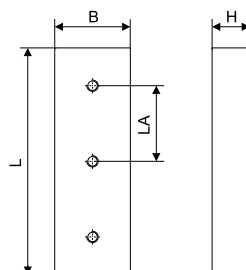
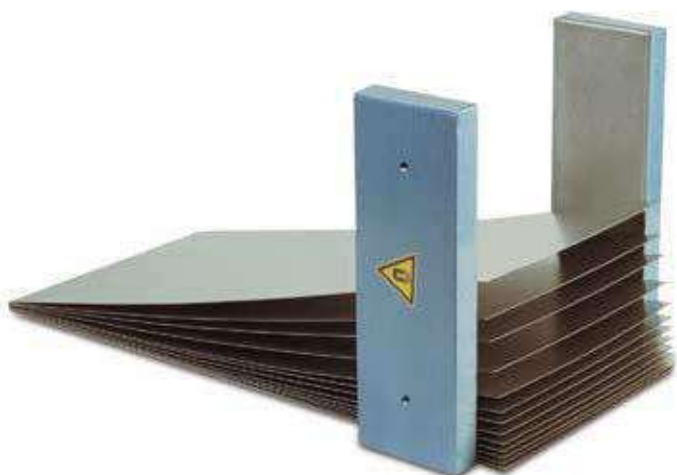

### Switchable Spreading Magnets

Especially in automated applications requiring, that spreading magnets must be switchable to the Standard magnets are built in stainless steel housings and tilted inside the housing with pneumatic or hydraulic drive elements.

### SELECTION CRITERIA

- Plate thickness / magnetic dimensions according to Table
- The sheet separators should have about 3 times the length of the sheet stack height
- Every spreader can spread approx 30 dm<sup>2</sup> plate surface, in highly oily sheets just 15 dm<sup>2</sup>, then a plurality of magnets are needed

### For Sheets up to 2,0 mm

Item-Nr.	Dimension (mm)			Drilling	LA (mm)	Weight (kg)
	L	W	H			
3005 2001	145	105	50	2 x M8	100	4,0
3005 2002	210	105	50	2 x M8	100	5,5
3005 2003	280	105	50	2 x M8	200	7,5
3005 2004	310	105	50	2 x M8	200	8,0
3005 2005	345	105	50	2 x M8	250	9,0
3005 2006	410	105	50	3 x M8	150	11,0
3005 2007	445	105	50	3 x M8	150	12,0
3005 2008	510	105	50	3 x M8	200	13,5
3005 2009	610	105	50	4 x M8	150	16,0
3005 2010	765	105	50	4 x M8	200	20,0

### For Sheets up to 0,7 mm

Item-Nr.	Dimension (mm)			Drilling	LA (mm)	Weight (kg)
	L	W	H			
3005 0701	75	75	30	2 x M8	50	1
3005 0702	275	75	30	2 x M8	250	3,5
3005 0703	340	75	30	2 x M8	250	4,5

### For Sheets up to 4,0 mm

Item-Nr.	Dimension (mm)			Drilling	LA (mm)	Weight (kg)
	L	W	H			
3005 4001	280	180	90	2 x M12	200	23,0
3005 4002	400	180	90	3 x M12	150	33,0

### For Sheets up to 1,0 mm

Item-Nr.	Dimension (mm)			Drilling	LA (mm)	Weight (kg)
	L	W	H			
3005 1001	105	105	30	2 x M8	50	2
3005 1002	210	105	30	2 x M8	100	3,5
3005 1003	310	105	30	2 x M8	200	5,5
3005 1004	340	105	30	2 x M8	250	6,0

### For Sheets up to 6,0 mm

Item-Nr.	Dimension (mm)			Drilling	LA (mm)	Weight (kg)
	L	W	H			
3005 6001	345	280	95	3 x M12	100	43,0
3005 6002	545	280	95	4 x M12	150	69,0
3005 6003	610	280	95	4 x M12	150	77,0
3005 6004	815	28	95	4 x M12	200	103,0

## SM Protective Magnets

Protective magnetic bar type SM are equipped with an extra-strong neodymium magnet system and fully protected by a stainless steel cover. They are used to protect machines, systems or vehicles against damage caused by metal parts. SM protective magnets can, for example, grown over/under mined bulk to container exterior walls or on vehicle tires. Even small metal parts are safely caught up to a distance of about 145mm. Several SM protective magnets can be fitted together to form a larger system.

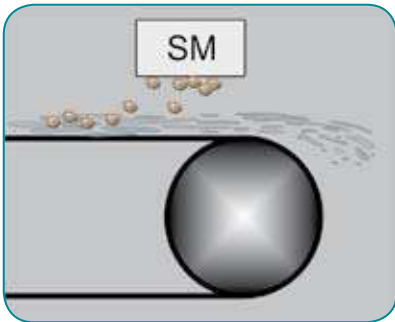

Sorting out on the conveyor belt



Tyre protection or Driveway cleaning on forklift



Model	Item-Nr.	Dimension (mm)			Drilling	Weight (kg)
		L	B	H		
SM 100	3016 0100	100	55	40	6xM6	1,7
SM 300	3016 0300	300	55	40	18xM6	5

## HR Magnetic Wheels

Permanent magnetic wheels are used to move or deflect sheet metal parts, can by using two adhesive wheels, for example flat metal parts are turned on a conveyor belt. Frequently, magnetic wheels are installed as head rollers of conveyor belts.



Magnetic wheels with a 2 pole pitch, NdFeB, drilling with fitting tolerance H7

Model	Item-Nr.	Dimension (mm)						Holding power (N)	Temperature °C	Weight (g)
		D	W	d	h	w				
HRZ 25	4080 25	25	16	8	8,6	3	30	100	50	
HRZ 32	4080 32	32	18	10	11,1	4	40	100	100	
HRZ 40	4080 40	40	20	12	13,1	4	60	100	200	
HRZ 50	4080 50	50	25	16	17,3	5	120	100	380	
HRZ 63	4080 63	63	32	20	21,7	6	180	100	700	
HRZ 80	4080 80	80	40	25	26,7	8	350	100	1500	
HRZ 100	4080 100	100	50	30	31,7	8	550	100	2900	
HRZ 125	4080 125	125	62	40	42,1	12	850	100	5500	
HRZ 160	4080 160	160	80	50	52,6	14	1400	100	9800	

Magnetic Wheels with fine pole pitch available on request

## MFS-ND Permanent Magnetic Filter Rods

Permanent Magnetic filter rods and magnetic grid can be used to clean granules, solids and liquids from metal particles. For this, the magnetic filters are easily integrated into the material flow. They are used in mechanical engineering, powder in waste separation, in the food industry, in agriculture and in all, granular and liquid processing equipment. The outer skin of the magnetic filter is made of wear-resistant stainless steel. A wide range of standard sizes - as well as nearly any desired size - are available. Tell us your application - we will gladly advise you.

Magnetic filter rods are the basic component for all magnetic filter systems. Filter rods of the type MFS-ND work with neodymium magnet systems. These have a max. Operating temperature of 80°C and produce a magnetic flux density of 12,000 gauss. On request, special dimensions, higher temperatures and flux densities possible to 14,000 Gauss.



The merger of several MFS-ND filter rods to a system also is possible.

Model	Item-Nr.	Dimension (mm)		Thread	Weight (g)
		L	ØD		
MFS-ND 22/100	3016 22100	100	22	2 * M6	271
MFS-ND 22/150	3016 22150	150	22	2 * M6	402
MFS-ND 22/200	3016 22200	200	22	2 * M6	555
MFS-ND 22/250	3016 22250	250	22	2 * M6	668
MFS-ND 22/300	3016 22300	300	22	2 * M6	805
MFS-ND 22/350	3016 22350	350	22	2 * M6	910
MFS-ND 22/400	3016 22400	400	22	2 * M6	1074
MFS-ND 22/450	3016 22450	450	22	2 * M6	1211
MFS-ND 22/500	3016 22500	500	22	2 * M6	1348
MFS-ND 22/550	3016 22550	550	22	2 * M6	1475
MFS-ND 22/600	3016 22600	600	22	2 * M6	1605
MFS-ND 25/100	3016 25100	100	25	2 * M6	365
MFS-ND 25/150	3016 25150	150	25	2 * M6	526
MFS-ND 25/200	3016 25200	200	25	2 * M6	704
MFS-ND 25/250	3016 25250	250	25	2 * M6	875
MFS-ND 25/300	3016 25300	300	25	2 * M6	1051
MFS-ND 25/350	3016 25350	350	25	2 * M6	1326
MFS-ND 25/400	3016 25400	400	25	2 * M6	1605
MFS-ND 25/450	3016 25450	450	25	2 * M6	1778
MFS-ND 25/500	3016 25500	500	25	2 * M6	1851
MFS-ND 25/550	3016 25550	550	25	2 * M6	2100
MFS-ND 25/600	3016 25600	600	25	2 * M6	2300

## PP1 Chips-Collector

The PP1 chips collector is used for the rapid collection of shavings and other metal parts, for cleaning the workplace, the machine or for the collection of metal parts from waste or ash. The collected metal parts are removed by pulling the rear release button.



Model	Item-Nr.	Dimension (mm)		Weight (kg)	Capacity ca. (kg)
		L	Ø		
PP1	3004 400	400	25 / 68	0,55	6



## MBR Magnetic Block

MBR magnetic blocks serve as additional support to reduce vibration when the workpiece overhangs the magnetic clamping plate or if 2 magnetic clamping plates are mounted at a large distance. Likewise MBR magnetic clamping blocks can form the 3-point support of the workpiece outside the magnetic chuck. On one side, the MBR is equipped with a powerful permanent magnetic base. The other side is brought to desired height above the massive, self-locking trapezoidal spindle. The MBR allows to set all levels needed for our magnetic clamping systems - from 82mm to 114mm. With additional adapter discs that are simply screwed onto the system, the height (H) can be extended.

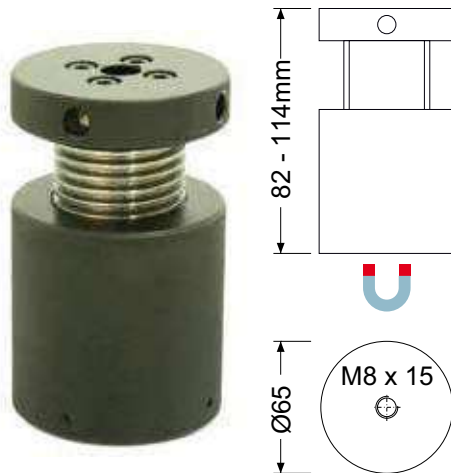

Model	Item-Nr.	Dimensions (mm)		Holding power (N)	Weight (kg)
		Ø	H		
MBR 65	2410 0065	65	82 - 114	280	1,8

## SWR Magnetic Angle

The magnetic clamping angle SWR 180 in the highest German quality. The extremely strong legs are separately switchable and the angle can be freely adjusted 45-225° and fixed with the locking screw. The prismatic base also allows to clamp round material



Model	Item-Nr.	Angle	Dimension (mm)		Holding power (N)	Weight (kg)
			L	W		
SWR 150	3007 113	30°-180°	150	38	400 / 400	1,7
SWR 180	3007 118	45°-225°	205	45	500 / 500	2,1

## SWR+ Magnetic Angle

The magnetic clamping angle SWR+ 170 can be fixed on the lateral locking screw in the working range between 30 and 270° in any position, the most common angle can be preset through locking positions. The strong, on both sides separately switchable ND magnetic system, generates 400 N holding force per leg. The prismatic base also allows to clamp round material.



Model	Item-Nr.	Angle	Dimension (mm)		Holding power (N)	Weight (kg)
			L	W		
SWR+ 170	3007 170	30 - 270°	170 x 170	45	400	2,1

## SWR-MS Magnetic Angle

The magnetic clamping angle SWR 150/90 and SWR 200/90 have two separately switchable legs, which stand to each other in the solid angle of 90°. The prismatic base also allows to clamp round material.

Model	Item-Nr.	Angle	Dimension (mm)		Holding power (N)	Weight (kg)	Gewicht (kg)
			L	W			
SWR-MS 150	3007 150	90°	150	150	38	500	1,7
SWR-MS 200	3007 200	90°	200	200	48	1100	2,8



## MSA Magnetic Angle

MSA Magnetic clamping angles are switchable, low-cost devices that have already proven themselves over a thousand times. Through its intelligent geometry MSA Magnetic clamping angle 45° and 90° internal angles are used.

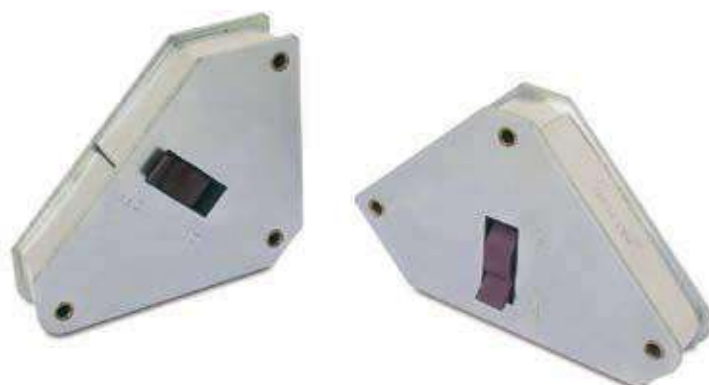

Model	Item-Nr.	Angle	Dimension (mm)		Holding power (N)	Weight (kg)	Gewicht (kg)
			L	W			
MSA klein	3007 202	45°, 90 °	111	95	29	350 / 350	0,8
MSA	3007 201	45°, 90 °	165	130	32	450 / 450	1,2

## MSF Magnetic Angle

MSF Magnetic clamping angles are switchable, low-cost devices that have already proven themselves over a thousand times. Through its intelligent geometry MSA Magnetic clamping angle 45° and 90° internal angles are used.

Model	Item-Nr.	Angle	Dimension (mm)		Holding power (N)	Weight (kg)	Gewicht (kg)
			L	W			
MFS 15	3007 315	90° fest	150	150	50	350 / 350	1,5
MFS 20	3007 320	90° fest	200	200	50	500 / 500	2,0
MFS 30	3007 330	90° fest	300	300	50	700 / 700	3,5



### SUB-BAND MAGNETS for Continuous grinding and brushing systems

Sub-band magnets are used in continuous grinding and brushing systems for punching, laser and laser cutting. To keep the cutting edges of the cutting machine during the transport on a conveyor belt through the work space of the machine and during processing.

In most cases, sub-band magnets are permanent magnets. However, Versions in electrical or electro-permanent technology can also be useful for some applications.

From different pre-planned standards, we design the appropriate sub-band magnets for your individual needs.



## SUB-BAND MAGNETS for Continuous grinding and brushing systems



Pole Pitch Ferrit 5+6

Model	Measuring Surface-field Power			1mm Air Gap Middle Pole	Pole Pitch
	Middle Pole	Edge Pole	Infeed Pole		
Sub band-magnet Magnetsystem Ferrit	2,8 Kilogauß	4,3 Kilogauß	800-1000 Gauß	11 Kilogauß	5+6 (5mm Steel, 6mm Ferrit)



Pole Pitch Ferrit 8+10

Model	Measuring Surface-field Power			1mm Air Gap Middle Pole	Pole Pitch
	Middle Pole	Edge Pole	Infeed Pole		
Sub band-magnet Magnetsystem Ferrit	1,5 Kilogauß	2,5 Kilogauß	600-800 Gauß	ca. 10 Kilogauß	8+10 (8mm Steel, 10mm Ferrit)



Pole Pitch Neodym 4+3

Model	Measuring Surface-field Power			1mm Air Gap Middle Pole	Pole Pitch
	Middle Pole	Edge Pole	Infeed Pole		
Sub band-magnet Magnet-system Neodym	3,4 Kilogauß	4,8 Kilogauß	-	8,9 Kilogauß	4+3 (4mm Steel, 3mm Neodym)



Pole Pitch Neodym 6+8

Model	Measuring Surface-field Power			1mm Air Gap Middle Pole	Pole Pitch
	Middle Pole	Edge Pole	Infeed Pole		
Sub band-magnet Magnetsystem Neodym	3,4 Kilogauß	5,9 Kilogauß	-	10,0 Kilogauß	6+8 (6mm Neodym, 8mm Steel)

Demagnetizing devices, also for the sub-band insert, can be found on pages 178-180

The subband magnetic systems shown here are common examples; Sub-band magnets are always manufactured according to customer requirements for the required application!

## Sub-band magnets and magnetic rollers for sheet transport and conveyor systems

Sub-band magnets are used to move workpieces during transport on tapes or slides. Safe to hold. Sub-band magnets hold both against the accelerating forces and the own Weight, as well as Against mechanical machining forces. Sub-magnets generally require the appropriate design. This relates to holding forces, transport direction, pole pitch and installation dimensions.

In most cases, sub-band magnets are permanent magnets. However, Versions in electrical or electro-permanent technology can also be useful for some applications.

From different pre-planned standards, we design the appropriate sub-band magnets for your individual needs.



### FLAME MAGNETS

Referred to as flame straightening Deforming sheet using electromagnets and high heat is mainly applied in the automotive industry to bring sheet metal element and walls in the form. We have experience in application and equipment - just ask us.

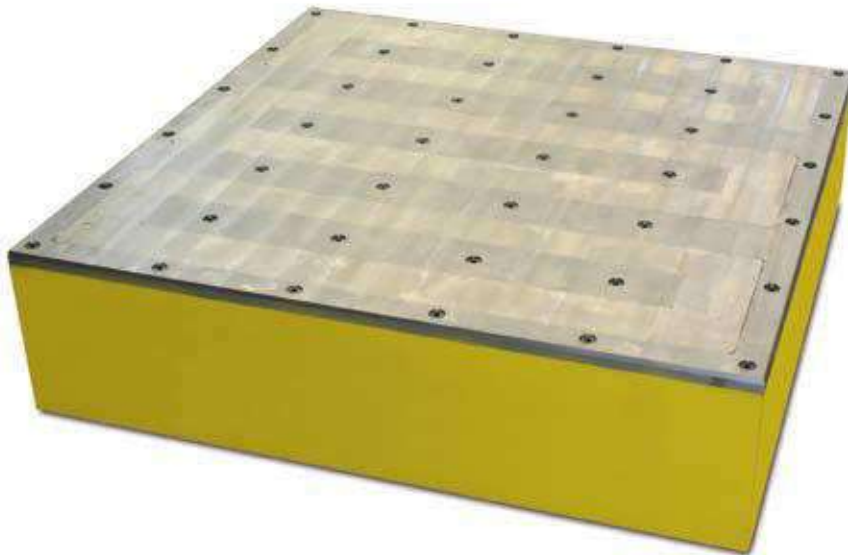

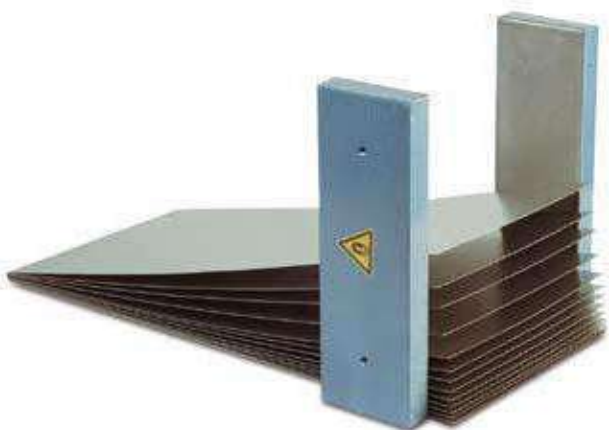

## MAGNETIC GRIPPING AND HOLDING

Holding Magnets and Magnetic Assemblies in various types are used in many areas of Tool, device and machine construction. They are used for holding, lifting and Connect in different places. In the following chapter „Magnetic Hold“ you will find a wide range of Permanent, electro-permanent and electro-magnetic systems. For technical questions and Selection Guide we are at your disposal.



**Page 153 - 154**

Electric holding bars and Circular magnets



**Page 154 - 155**

Electro-permanent adhesive rods and circular magnets



**Page 156**

Pneumatically actuated permanent magnet gripper



**Page 38 - 40**

FXE-M Electro-Permanent Lifting Magnet Modules



**Page 157**

Permanent bar and flat grippers



**Page 171**

ALNICO Special Magnets



**Page 173 - 174**

Permanent Raw Magnets

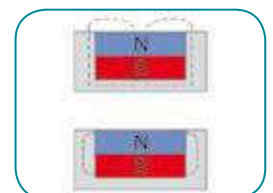

**Page 175**

Installation instructions for Permanent Magnets



## EHG Electromagnetic Holding Bars

EHG Electromagnetic holding bars are used in fixture for gripper systems and for a variety of tasks in mechanical engineering. EHG holding bars consist of a bolted, two-part system, are two-layer coated and sealed to IP 65.

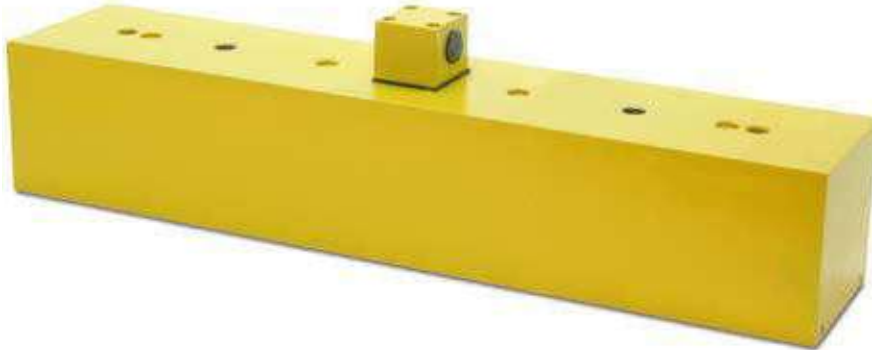

Max. Operation temperature 60°C.  
Standard Voltage 24, 48, 110 V DC.  
Protection class IP 53  
ED 100%

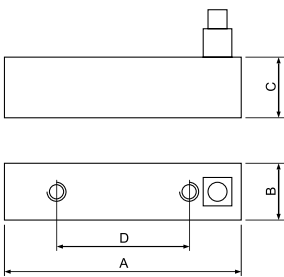

Model	Item-Nr.	Dimension (mm)				Drilling	Performance (W)	Holding power		Weight (kg)
		A	B	C	D			(kN)	from (mm)	
EHG 2085	4010 2085	200	80	50	100	2 x M12	28	4,4	12	6
EHG 4085	4010 4085	400	80	50	200	2 x M12	51	10,5	12	12
EHG 5085	4010 5085	500	80	50	300	2 x M12	64	14	12	16
EHG 4088	4010 4088	400	80	80	200	2 x M12	79	10	12	20
EHG 5017	4010 5017	500	100	70	300	2 x M12	70	15	25	28
EHG 8017	4010 8017	800	100	70	500	2 x M12	123	24	25	45
EHG 1158	4010 1158	1000	150	80	300	3 x M12	240	36	35	80

Other dimensions on request!

## EHF Electromagnetic Holding Bars

EHF electromagnetic holding bars in compact, sealed design are used in the fixture, for gripper systems and for a variety of tasks in mechanical engineering. EHF holding bars are manufactured massively in a mono-block and have a nickel-plated surface. They are sealed to IP 65.

The cable entry can be fitted to the side or from behind. The terminal compartment is then shed with silicone or synthetic resin. Compared to EHG holding bars they are better suited for materials with low thickness.



Max. Operation temperature 60°C.  
Standard Voltage 24 V DC  
Protection class IP 65  
ED 100%

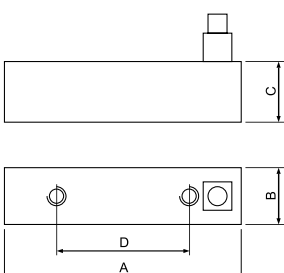

Model	Item-Nr.	Dimension (mm)				Drilling	Performance (W)	Holding power		Weight (kg)
		A	B	C	D			(kN)	from (mm)	
EHF 1030	4011 1030	100	32	31	50	2 x M6	7	0,88	8	0,6
EHF 1530	4011 1530	150	32	31	50	3 x M6	11	1,5	8	0,9
EHF 2030	4011 2030	200	32	31	50	4 x M6	14	2,1	8	1,2
EHF 4030	4011 4030	400	32	31	50	8 x M6	35	4,7	8	2,5
EHF 5030	4011 5030	500	32	31	50	10 x M6	35	6	8	3,2
EHG 6030	4011 6030	600	32	31	50	12 x M6	42	7,2	8	3,8

## EHP-ND Electro-Permanent Magnetic Base

EHP-ND electro-permanent magnet bases are made of a strong permanent-magnetic adhesive system and from an excitation winding which allows neutralized in the ON state, the magnetic field to the adhesive surfaces and thus the removal or withdrawal of the workpiece. EHP-ND magnetic bases are particularly well suited as a holding and lifting magnets where high reliability is required. EHP-ND magnetic bases have a fully encapsulated coil, powder-coated and sealed to IP65.



Max. Operation temperature 60°C.  
Standard Voltage 207 V DC  
Protection class IP 65  
ED of the coil 10%

Model	Item-Nr.	Dimension (mm)			Drilling	Performance (W)	Holding power		Weight (kg)
		L	W	H			(kN)	from (mm)	
EHP-ND 500	4019 500	175	85	53	4 x M6	430	5	10	6
Other dimensions on request!									

## EHRP-ND Electro-Permanent Roundmagnets

EHRP-ND electro-permanent magnets consist of a circular permanent-magnetic adhesive system and from an excitation winding permitting neutralized in the ON state, the magnetic field to the adhesive surfaces and thus the removal or withdrawal of the workpiece. Because of the permanent-magnetic character of EHRP-ND round magnets these are preferably used where long periods of detention are required and the holding force must be suppressed for a short time or occasionally. EHRP-ND round magnets are especially suited as safety magnets and where high reliability is required. EHRP-ND round magnets have a fully encapsulated coil, nickel and sealed to IP 65. The connection is made on the back running cable.



Max. Operation temperature 60°C.  
Standard Voltage 24 V DC  
Protection class IP 65  
ED of the coil 10%



Model	Item-Nr.	Dimension (mm)		Drilling	Performance (W)	Holding power		Weight (kg)
		Ø	H			(N)	from (mm)	
EHRP-ND 2425	4019 2425	25	29	M4	9	100	3	0,1
EHRP-ND 2450	4019 2450	50	29	M5	39	400	5	0,4
EHRP-ND 2482	4019 2482	82	45	M8	60	1500	8	1,5
EHRP-ND 24150	4019 24150	150	65	M16	88	3000	12	6,4

## EHR-24V Electro Roundmagnets

EHR-24V electric circular magnets have a fully encapsulated coil, nickel and sealed to IP 65. The connection is made on the back running cable. On request EHR round magnets with lateral terminal available.



Max. Operation temperature 60°C.  
Standard Voltage 24 V DC.  
Protection class IP 65  
ED 100%

Model	Item-Nr.	Dimension (mm)		Drilling	Performance (W)	Holding power (N)		Weight (kg)
		Ø	H			from (mm)		
EHR 2415	4016 02415	15	12	1 x M3	1,4	36	2	0,02
EHR 2418	4016 02418	18	11	1 x M3	1,4	40	2	0,02
EHR 2425	4016 02425	25	20	1 x M4	3,2	140	3	0,06
EHR 2432	4016 02432	32	22	1 x M4	3,6	230	3,6	0,11
EHR 2440	4016 02440	40	25	1 x M5	5,2	450	4,5	0,2
EHR 2450	4016 02450	50	27	1 x M5	6,5	700	6	0,3
EHR 2463	4016 02463	63	30	1 x M8	9	950	7	0,55
EHR 2470	4016 02470	70	35	1 x M8	12	1500	8	1,1
EHR 2480	4016 02480	80	38	1 x M8	15	1800	9	1,2
EHR 2490	4016 02490	90	42	1 x M8	14	3000	12	1,8
EHR 24100	4016 24100	100	43	1 x M10	21	3200	10,5	2,1
EHR 24150	4016 24150	150	56	1 x M16	37	9000	17	6,4
EHR 24180	4016 24180	180	63	1 x M24	50	15000	21	10,5
EHR 24250	4016 24250	250	80	1 x M24	90	30000	29	25,9

## EHRF-24V Electro Roundmagnets

EHRF-24V in flat construction have a fully encapsulated coil, nickel and sealed to IP 65. The connection is made on the back running cable.

EHRF can be screwed from the front or it can be introduced threaded holes from the rear.



Max. Operation temperature 60°C.  
Standard Voltage 24 V DC.  
Protection class IP 65  
ED 100%

Model	Item-Nr.	Dimension (mm)		Drilling	Performance (W)	Holding power (N)		Weight (kg)
		Ø	H			from (mm)		
EHRF 2456	4017 02456	56	13	6,6 / 22	6	750	4	0,17
EHRF 24110	4017 24110	110	21	6,6 / 40	16	2050	7	0,9
EHRF 24170	4017 24170	170	29	6,6 / 76	32	5000	10	3

\* Inner diameter / max. PCD

## PNEUMAG Pneumatically actuated Gripper

Pneumatically actuated magnetic grippers type PNEUMAG are bi-stable magnet systems which can be switched via compressed air.

That is, Air pressure is only required for switching. The magnet system is permanent and thus also is safe when pressure drops.

PNEUMAG magnetic grippers enable thin, perforated or structured sheet metal (from 0.5 mm) to be picked up safely, which is especially recommended for use in automatic and semi-automatic feeding systems as well as a stop means for robot grippers. PNEUMAG is the alternative to vacuum transport systems.

They were tested on a steel sheet with a smooth, clean surface.

Note that depending on the application, a safety factor of 2 or 3 must be included.

PNEUMAG is available in Rubber and Blank. The rubber sole should prevent slipping off the load.

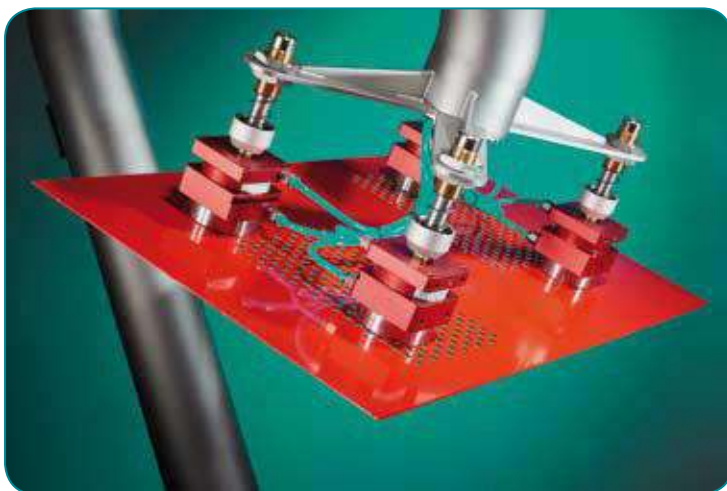

PNEUMAG is available in Rubber and Blank. The rubber sole should prevent slipping off the load.

Model	Item-Nr.	Dimension (mm)			Drilling	Holding Power		Weight (kg)
		L	B	H		(N)	from (mm)	
PNEUMAG 40/40 rubber	4020 310	46	46	63	1xM8	140	2	0,2
PNEUMAG 70/70 rubber	4020 305	76	76	71	1xM10	340	2	0,8
PNEUMAG 100/100 rubber	4020 300	106	106	71	1xM10	1000	2	2,7
Other dimensions on request!								

Model	Item-Nr.	Dimension (mm)			Drilling	Holding Power		Weight (kg)
		L	B	H		(N)	from (mm)	
PNEUMAG 40/40 blank	4020 311	40	40	63	1xM8	170	2	0,2
PNEUMAG 70/70 blank	4020 306	70	70	70	1xM10	400	2	0,7
PNEUMAG 100/100 blank	4020 301	100	100	70	1xM10	1300	2	1,5
Other dimensions on request!								

## FLAT- AND ROD GRIPPER

On the following pages you will find permanent magnetic flat and rod gripper. It is in these embodiments the magnet systems have only one adhesive surface due to their construction. Of all the other surfaces of the gripper magnet body assumes no magnetic force. This construction shape makes it possible, to limit the spatial effect of the magnetic field, so that it does not come to a surrounding magnetization of the entire, which is in contact with the gripper magnet, workpiece or the gripper magnet machine elements.



The holding forces given in the tables are nominal at room temperature which can be reached at normal demolition and full surface contact of the gripper bar on workpieces of sufficient thickness of mild iron or mild steel. For unclean pole faces or uneven workpieces to form air gaps, through which the adhesive forces are greatly reduced. It is advisable to always ensure a clean pole face and if necessary to clean from time to time.

The pot magnets described are not aging. They keep their adhesive force for an unlimited period. They can be weakened only by excessively high operating temperatures and mechanical destruction.

Different workpieces influence the adhesive force according to their permeability. With increasing admixtures and alloying components the permeability and thus the adhesive force decreases. Larger surface roughness on the workpiece leader due to the decrease of the support portion in substantial holding power losses. With increasing air gap, the adhesive force of pot magnets decreases. Magnetically non-conducting intermediate layers act in the same sense as an air gap. Should be concerned with long-term temperature or thermal shock stresses malfunctions, please send us your inquiry. The same applies in the event of chemical stresses.

**Note:**

The holding forces have been determined on a ground plate (material St37) with a thickness of 10mm by the vertical withdrawal of the magnet (1 kg about 10 N). Any differences up to -10 % of the specified values are possible.

## SMCO Rod gripper in brass housing

Rod gripper in SmCo, brass body with fitting tolerance h6, high bond strength and small size under medium temperature influence.



With fit tolerance, shortened to measure C

Item-Nr.	Dimension (mm)				Holding power (N)	Weight (g)	Temperature (°C)
	ØA h6	B	C	D			
4011 06	6	20	10	1,5	8	4,5	200
4011 08	8	20	10	1,5	22	8	200
4011 10	10	20	8	2	40	12,5	200
4011 13	13	20	6	2,5	60	20	200
4011 16	16	20	2	3	125	32	200
4011 20	20	25	5	4	250	60	200
4011 25	25	35	7	5	400	135	200
4011 32	32	40	4	6	600	250	200

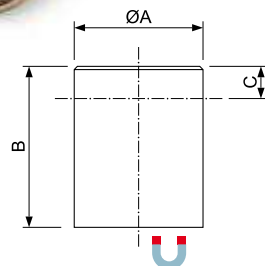

## NDFEB Rod gripper in brass housing

Rod gripper in NdFeB, brass body with fitting tolerance h6. Highest holding power and small size. NdFeB rod gripper are colored blue on the adhesive surface.

With fit tolerance, shortened to measure C

Item-Nr.	Dimension (mm)				Holding power (N)	Weight (g)	Temperature (°C)
	ØA h6	B	C	D			
4010 06	6	20	10	1,5	10	4,5	80
4010 08	8	20	10	1,5	25	8	80
4010 10	10	20	8	2	45	12	80
4010 13	13	20	6	2,5	70	20	80
4010 16	16	20	2	3	150	30	80
4010 20	20	25	5	4	280	59	80
4010 25	25	35	7	5	450	132	80
4010 32	32	40	5	6	720	246	80



With fit tolerance and thread, not shortened

Item-Nr.	Dimension (mm)			Thread MxL (mm)	Holding power (N)	Weight (g)	Temperature (°C)
	ØA h6	B	D				
4022 06	6	20	1,5	M3 x 5	10	4	80
4022 08	8	20	1,5	M3 x 5	25	7,5	80
4022 10	10	20	2	M4 x 7	45	11	80
4022 13	13	20	2,5	M4 x 7	70	19,5	80
4022 16	16	25	3	M4 x 8	150	38	80
4022 20	20	25	4	M6 x 6	280	58	80
4022 25	25	35	5	M6 x 8	450	130	80
4022 32	32	40	6	M6 x 6	720	243	80

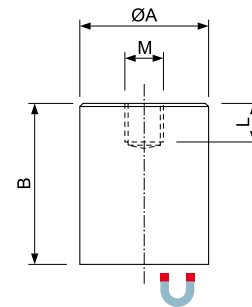

At the adhesive surface removably to measure D

Item-Nr.	Dimension (mm)			Holding power (N)	Weight (g)	Temperature (°C)
	ØA ±0,2	B	D			
4029 06	6	20	3	6	4	80
4029 08	8	20	3	12	7,5	80
4029 10	10	20	5	24	11	80
4029 13	13	20	5	60	20	80
4029 16	16	20	6	90	30	80
4029 20	20	25	7	135	58	80
4029 25	25	35	8	190	131	80
4029 32	32	40	10	340	243	80

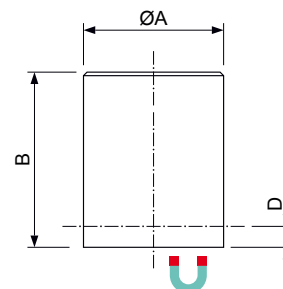

**Note:**  
Rod gripper in brass housing must not be installed directly into iron molds with magnetic surfaces. To avoid a loss of adhesive force is the distance to iron-wall according measure complied D necessarily. The distance must be maintained even after the rear when the magnet system has been shortened by the dimension C. The length B will be max. reduced by C level without the adhesive force decreases.

## ALNICO Rod gripper in Steel housing

Rod gripper AlNiCo, steel housing in 3 versions

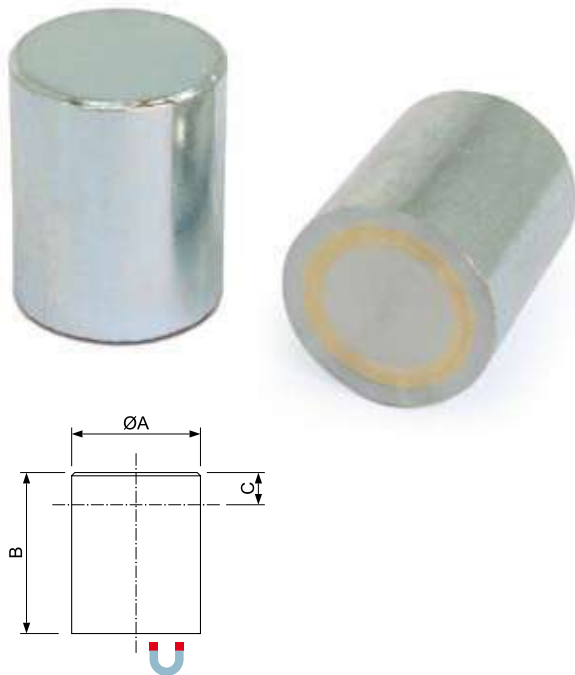

Standard, shortened to measure C

Item-Nr.	Dimension (mm)			Holding power (N)	Weight (g)	Temperature (°C)
	ØA ±0,2	B	C			
4023 06	6	20	12	2	4,5	450
4023 08	8	20	11	4	7,5	450
4023 10	10	20	10	8,5	12	450
4023 13	13	20	8	12	19	450
4023 16	16	20	6	20	30	450
4023 20	20	25	5	40	58	450
4023 25	25	35	13	60	125	450
4023 32	32	40	9	160	220	450
4023 40	40	50	10	240	440	450
4023 50	50	60	10	400	813	450
4023 63	63	65	10	660	1306	450

Fit tolerance h6, shortened to measure C

Item-Nr.	Dimension (mm)			Holding power (N)	Weight (g)	Temperature (°C)
	ØA h6	B	C			
4012 06	6	10	2	2	2	450
4012 08	8	12	3	4	4,5	450
4012 10	10	16	6	8,5	9,5	450
4012 13	13	18	6	12	18	450
4012 16	16	20	6	20	30	450
4012 20	20	25	5	40	57	450
4012 25	25	30	7	60	106	450
4012 32	32	35	4	160	187	450
4012 40	40	45	5	240	390	450
4012 50	50	50	-	400	639	450
4012 63	63	60	5	660	1175	450

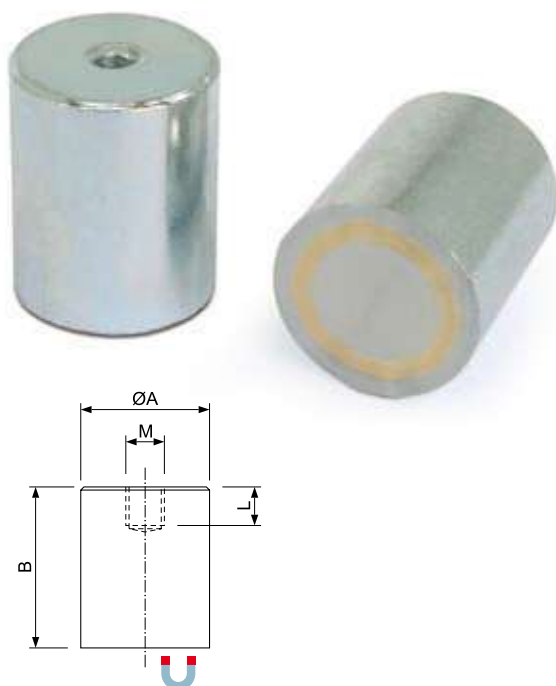

Standard with Thread, not shortened

Item-Nr.	Dimension (mm)		Thread MxL (mm)	Holding power (N)	Weight (g)	Temperature (°C)
	ØA h6	B				
4013 06	6	20	M3 x 5	2	4	450
4013 08	8	20	M3 x 5	4	7,5	450
4013 10	10	20	M4 x 7	8,5	11	450
4013 13	13	20	M4 x 7	12	19	450
4013 16	16	20	M4 x 5	20	30	450
4013 20	20	25	M6 x 7	40	55	450
4013 25	25	35	M6 x 9	60	121	450
4013 32	32	40	M8 x 9	160	220	450
4013 40	40	50	M8 x 9	240	440	450
4013 50	50	60	M10 x 12	400	750	450
4013 63	63	65	M10 x 12	660	1280	450

## NDFEB Rod gripper in Steel housing

Rod gripper in NdFeB, steel housing in 3 versions.

### Standard, shortened to measure C

Item-Nr.	Dimension (mm)			Holding power (N)	Weight (g)	Temperature (°C)
	ØA ±0,2	B	C			
4025 04	4	20	15	2,5	2	80
4025 05	5	20	15	4,5	3	80
4025 06	6	20	15	6	4,5	80
4025 08	8	20	15	12	8	80
4025 10	10	20	15	24	12	80
4025 13	13	20	15	60	21	80
4025 16	16	20	15	90	31	80
4025 20	20	25	18	135	61	80
4025 25	25	35	27	190	133	80
4025 32	32	40	32	340	249	80



### Fit tolerant h6, shortened to measure C

Item-Nr.	Dimension (mm)			Holding power (N)	Weight (g)	Temperature (°C)
	ØA h6	B	C			
4028 06	6	10	5	6	2	80
4028 08	8	12	7	12	5	80
4028 10	10	16	11	24	10	80
4028 13	13	18	13	60	18	80
4028 16	16	20	15	90	31	80
4028 20	20	25	18	135	61	80
4028 25	25	30	22	190	114	80
4028 32	32	35	27	340	217	80

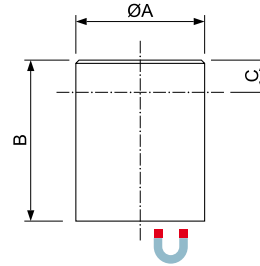

### Standard with thread, not shortened

Item-Nr.	Dimension (mm)			Holding power (N)	Weight (g)	Temperature (°C)
	ØA ±0,2	B	Thread MxL (mm)			
4027 06	6	20	M3 x 5	6	4	80
4027 08	8	20	M3 x 5	12	7,5	80
4027 10	10	20	M4 x 7	24	11	80
4027 13	13	20	M4 x 7	60	20	80
4027 16	16	20	M4 x 7	90	30	80
4027 20	20	25	M6 x 9	135	58	80
4027 25	25	35	M6 x 9	190	131	80
4027 32	32	40	M8 x 12	340	243	80
4027 40	40	50	M8 x 12	700	480	80
4027 50	50	60	M10 x 12	1000	900	80
4027 63	63	65	M12 x 14	1700	1560	80

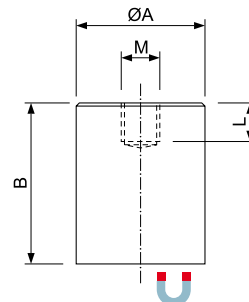



## ALNICO Rod gripper in Steel housing

Rod gripper AlNiCo, steel body painted red and internal thread

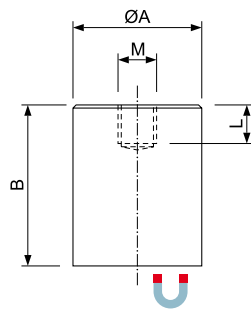

Item-Nr.	Dimension (mm)		Thread MxL (mm)	Holding power (N)	Weight (g)	Temperature (°C)
	ØA ±0,2	B				
4031 12	12,5	16	M4 x 7	20	15	220
4031 17	17	16	M6 x 5	26	29	220
4031 21	21	19	M6 x 7	40	50	220
4031 27	27	25	M6 x 9	65	98	220
4031 35	35	30	M6 x 9	150	205	220
4031 65	65	43	M12 x 13	400	1060	220

## HARTFERRIT Flat gripper

Flat pot magnets hard ferrite with threaded bush, galvanized

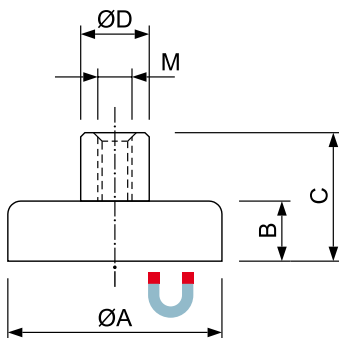

Item-Nr.	Dimension (mm)				Thread (M)	Holding power (N)	Weight (g)	Temperature (°C)
	ØA	B	C	ØD				
4035 01006	10	4,5	11,5	6	M3	4	3	200
4035 01306	13	4,5	11,5	6	M3	10	4	200
4035 01606	16	4,5	11,5	6	M3	18	6	200
4035 02006	20	6	13	6	M3	30	11	200
4035 02508	25	7	15	8	M4	40	20	200
4035 03208	32	7	15	8	M4	80	31	200
4035 03608	36	7,7	16	8	M4	100	42	200
4035 04008	40	8	16,5	8	M4	125	57	200
4035 04010	40	8	18	10	M5	125	59	200
4035 04708	47	9	17	8	M4	180	86	200
4035 04712	47	9	21	12	M6	180	91	200
4035 05008	50	10	18,5	8	M4	220	105	200
4035 05012	50	10	22	12	M6	220	111	200
4035 05708	57	10,5	18,5	8	M4	280	147	200
4035 05712	57	10,5	22,5	12	M6	280	153	200
4035 06308	63	14	22	8	M4	350	228	200
4035 06315	63	14	30	15	M8	350	245	200
4035 08012	80	18	28,5	12	M6	600	477	200
4035 08020	80	18	34	20	M10	600	499	200
4035 10022	100	22	43	22	M12	900	956	200
4035 12525	125	26	50	25	M14	1300	1720	200

## HARTFERRIT Flat gripper

Flat pot magnets hard ferrite with threaded bush in a stainless steel housing. The systems with stainless steel housing are particularly suitable for rooms with special hygiene requirements.

They also have excellent resistance to chemicals and can therefore also be used with galvanic applications. In addition, a higher temperature resistance is achieved.

Item-Nr.	Dimension (mm)				Thread (M)	Holding power (N)	Weight (g)	Temperature (°C)
	ØA	B	C	ØD				
4036 25	25	7	16	8	M5	32	20	220
4036 32	32	7	16	8	M5	64	31	220
4036 40	40	8	16,5	8	M5	100	56	220
4036 50	50	10	18,5	8	M5	175	105	220
4036 63	63	14	22	8	M5	280	228	220

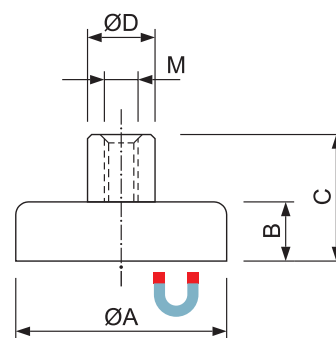

## HARTFERRIT Flat gripper

Flat pot magnets hard ferrite, with threaded rod galvanized

Item-Nr.	Dimension (mm)			Thread (M)	Holding power (N)	Weight (g)	Temperature (°C)
	ØA	B	C				
4037 1007	10	4,5	7	M3	4	2	200
4037 1308	13	4,5	7	M3	10	3	200
4037 1607	16	4,5	7	M3	18	5	200
4037 1606	16	4,5	6	M4	18	5	200
4037 2007	20	6	7	M3	30	10	200
4037 2030	20	6	30	M6	30	15	200
4037 2508	25	7	8	M4	40	19	200
4037 2515	25	7	15	M5	40	20	200
4037 2520	25	7	20	M6	40	22	200
4037 3208	32	7	8	M4	80	30	200
4037 3212	32	7	12	M6	80	31	200
4037 3210	32	7	10	M8	80	32	200
4037 4708	47	9	8	M6	180	85	200
4037 5708	57	10,5	8	M6	280	146	200
4037 6315	63	14	15	M6	350	233	200

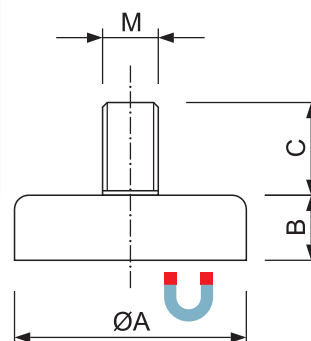

## HARTFERRIT Flat gripper

Flat pot magnets hard ferrite, galvanized

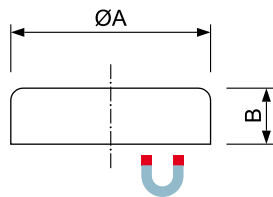

Item-Nr.	Dimension (mm)		Holding power (N)	Weight (g)	Temperature (°C)
	ØA	B			
4038 010	10	4,5	4	2	200
4038 013	13	4,5	10	3	200
4038 016	16	4,5	18	5	200
4038 020	20	6	30	10	200
4038 025	25	7	40	18	200
4038 032	32	7	80	29	200
4038 036	36	7,7	100	39	200
4038 040	40	8	125	55	200
4038 047	47	9	180	84	200
4038 050	50	10	220	102	200
4038 057	57	10,5	280	141	200
4038 063	63	14	350	226	200
4038 080	80	18	600	468	200
4038 100	100	22	900	915	200
4038 125	125	26	1300	1680	200

## HARTFERRIT Flat gripper

Flat pot magnets hard ferrite with bore and counter bore, galvanized

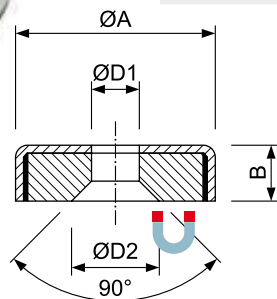

Item-Nr.	Dimension (mm)				Holding power (N)	Weight (g)	Temperature (°C)
	ØA	B	ØD1	ØD2			
4039 16	16	4,5	3,5	6,5	14	4	200
4039 20	20	6	4,2	9,4	27	9	200
4039 25	25	7	5,5	11,5	36	17	200
4039 32	32	7	5,5	11,5	72	27	200
4039 40	40	8	5,5	11,5	90	52	200

## HARTFERRIT Flat gripper

Flat pot magnets hard ferrite with bore and counter-bore in stainless steel housing. The systems with stainless steel housing are particularly suitable for rooms with special hygiene requirements. They also have excellent resistance to chemicals and can therefore also be used with galvanic applications. In addition, a higher temperature resistance is achieved.

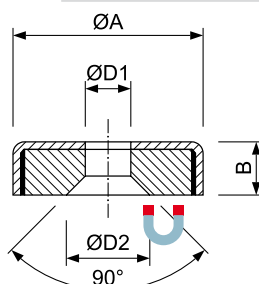

Item-Nr.	Dimension (mm)				Holding power (N)	Weight (g)	Temperature (°C)
	ØA	B	ØD1	ØD2			
4040 20	20	6	4,2	9,4	22	9	220
4040 25	25	7	5,5	11,5	29	17	220
4040 32	32	7	5,5	11,5	58	27	220
4040 40	40	8	5,5	11,5	72	52	220

## HARTFERRIT Flat gripper

Flat pot magnets hard ferrite with cylinder-bore, galvanized

Item-Nr.	Dimension (mm)				Holding power (N)	Weight (g)	Temperature (°C)
	ØA	B	ØD1	ØD2			
4041 05010	50	10	8,5	22	180	85	200
4041 05711	57	11	6,5	24	230	130	200
4041 06314	63	14	6,5	24	290	197	200
4041 08010	80	10	6,4	32	450	235	200
4041 08018	80	18	6,5	11,5	540	458	200
4041 08318	83	18	10,5	32	600	444	200
4041 10022	100	22	10,5	34	680	815	200

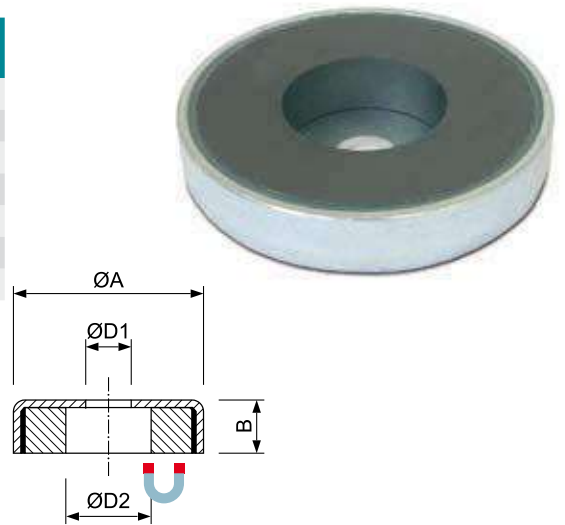

## HARTFERRIT Flat gripper

Flat pot magnets hard ferrite with cylinder-bore in stainless steel housing. The systems with stainless steel housing are particularly suitable for rooms with special hygiene requirements. They also have excellent resistance to chemicals and can therefore also be used with galvanic applications. In addition, a higher temperature resistance is achieved.

Item-Nr.	Dimension (mm)				Holding power (N)	Weight (g)	Temperature (°C)
	ØA	B	ØD1	ØD2			
4042 50	50	10	8,5	22	145	85	220
4042 63	63	14	6,5	24	230	195	220

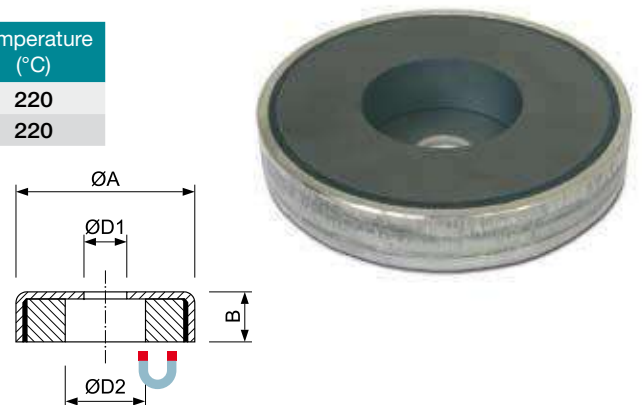

## HARTFERRIT Flat gripper

Flat pot magnets hard ferrite with internal thread, galvanized

Item-Nr.	Dimension (mm)				Thread (M)	Holding power (N)	Weight (g)	Temperature (°C)
	ØA	B	ØC	M				
4043 2504	25	7	5,2	M4	36	18	200	
4043 3204	32	7	5,2	M4	75	29	200	
4043 4004	40	8	5,2	M4	90	53	200	
4043 5006	50	10	12	M6	170	94	200	
4043 5008	50	10	12	M8	170	94	200	
4043 6308	63	14	13	M8	290	206	200	
4043 8008	80	18	14,5	M8	550	472	200	
4043 8010	80	18	14,5	M10	550	466	200	

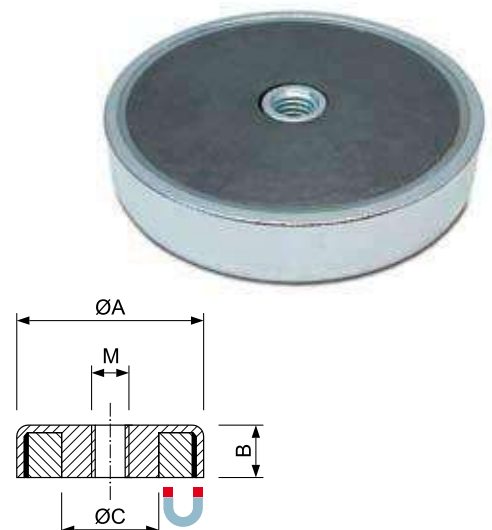

## NDFEB Flat gripper

Flat Gripper with threaded bush in NdFeB, galvanized

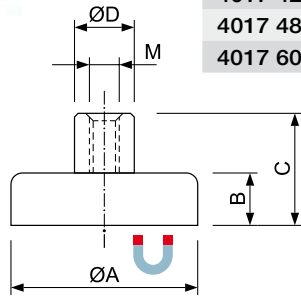

Item-Nr.	Dimension (mm)				Thread (M)	Holding power (N)	Weight (g)	Temperature (°C)
	ØA	B	C	ØD				
4017 10	10	5	12	5,5	M3	25	3	80
4017 12	12	5	13	6	M3	55	5	80
4017 16	16	5	13	6	M4	95	8	80
4017 20	20	7	15	8	M4	140	17	80
4017 25	25	8	17	10	M5	200	25	80
4017 32	32	8	18	10	M5	350	48	80
4017 36	36	8	18	10	M6	450	60	80
4017 42	42	9	20	12	M6	580	78	80
4017 48	48	11	24	12	M8	800	94	80
4017 60	60	15	30	14	M10	1150	110	80

## NDFEB Flat gripper

NdFeB flat pot, galvanized

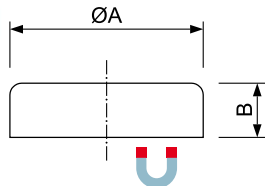

Item-Nr.	Dimension (mm)		Holding power (N)	Weight (g)	Temperature (°C)
	ØA	B			
4019 06	6	4,5	6	1	80
4019 08	8	4,5	13	1,5	80
4019 10	10	4,5	25	2,5	80
4019 13	13	4,5	60	4,5	80
4019 16	16	4,5	100	6,5	80
4019 20	20	6	150	15	80
4019 25	25	7	200	22	80
4019 32	32	7	350	40	80

## NDFEB Flat gripper

Flat gripper with threaded pin in NdFeB, galvanized

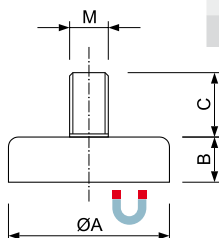

Item-Nr.	Dimension (mm)			Thread (M)	Holding power (N)	Weight (g)	Temperature (°C)
	ØA	B	C				
4016 10	10	5	7	M3	25	3	80
4016 12	12	5	8	M3	55	5	80
4016 16	16	5	8	M4	95	8	80
4016 20	20	7	8	M4	140	17	80
4016 25	25	8	9	M5	200	25	80
4016 32	32	8	10	M6	350	48	80
4016 36	36	8	10	M6	450	60	80
4016 42	42	9	11	M6	580	78	80
4016 48	48	11	13	M6	800	94	80
4016 60	60	15	15	M8	1150	110	80

## NDFEB Flat gripper

NdFeB flat pot with bore, galvanized

Item-Nr.	Dimension (mm)				Holding power (N)	Weight (g)	Temperature (°C)
	ØA	B	ØD1	ØD2			
4014 16	16	5	3,5	6,5	75	4	80
4014 20	20	7	4,5	8,6	105	12	80
4014 25	25	8	5,5	10,4	160	22	80
4014 32	32	8	5,5	10,4	310	40	80
4014 42	42	9	6,5	12	520	80	80
4014 48	48	11,5	8,5	16	660	100	80
4014 60	60	15	8,5	16	880	120	80
4014 75	75	18	10,5	19	110	150	80

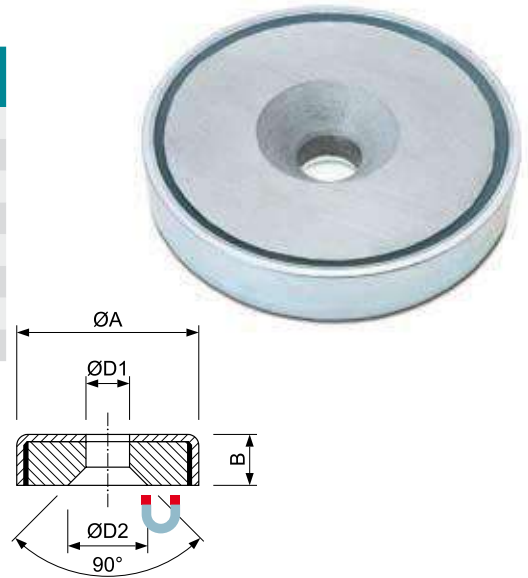

## NDFEB Flat gripper

NdFeB flat pot with cylinder bore, galvanized

Item-Nr.	Dimension (mm)				Holding power (N)	Weight (g)	Temperature (°C)
	ØA	B	ØD1	ØD2			
4015 16	16	5	3,5	6,5	75	4	80
4015 20	20	7	4,5	8	105	12	80
4015 25	25	8	5,5	9	160	22	80
4015 32	32	8	5,5	9	310	40	80
4015 42	42	9	6,5	11	520	80	80
4015 48	48	11,5	8,5	15	660	100	80
4015 60	60	15	8,5	15	880	120	80
4015 75	75	18	10,5	18	1100	150	80

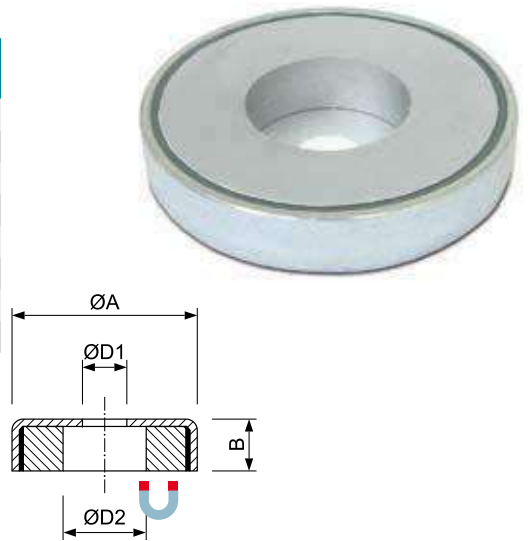

## NDFEB Flat gripper

Flat Gripper with internal thread in NdFeB, galvanized

Item-Nr.	Dimension (mm)			Thread (M)	Holding power (N)	Weight (g)	Temperature (°C)
	ØA	B	ØC				
4048 32	32	7	5,5	M5	330	40	80
4048 40	40	8	10,5	M5	500	74	80
4048 50 *	50	10	9,5	M8	800	140	80
4048 63 *	63	14	11,7	M10	1100	315	80
4048 75 *	75	15	13	M10	1750	479	80

\* With these dimensions, the adhesive surface is protected by a plastic coating.

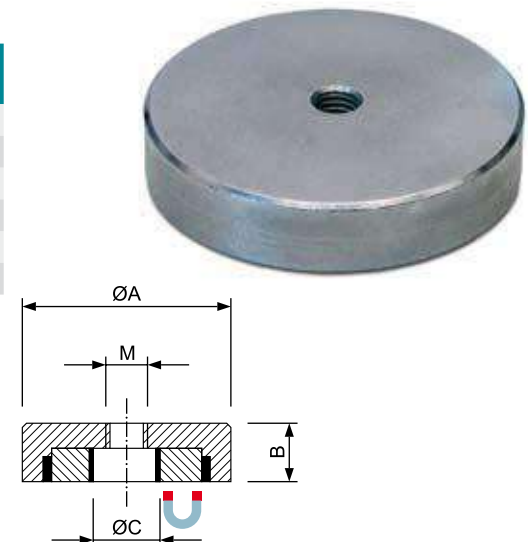

## NDFEB Flat gripper

NdFeB flat pot with mounted hook, galvanized

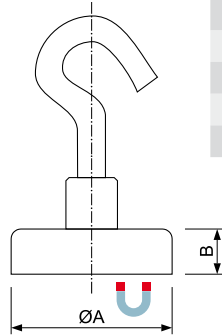

Item-Nr.	Dimension (mm)		Holding power (N)	Weight (g)	Temperature (°C)
	ØA	B			
4018 16	16	5	75	4	80
4018 20	20	7	105	12	80
4018 25	25	8	160	22	80
4018 32	32	8	310	40	80
4018 42	42	9	580	80	80
4018 48	48	11,5	800	100	80
4018 60	60	15	1150	120	80
4018 75	75	18	1600	150	80

## SMCO Flat gripper

Flat pot SmCo with threaded bush, galvanized

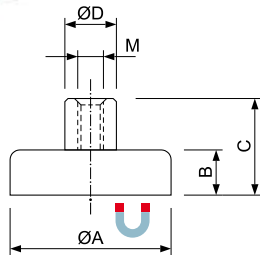

Item-Nr.	Dimension (mm)				Thread (M)	Holding power (N)	Weight (g)	Temperature (°C)
	ØA	B	C	ØD				
4049 06	6	4,5	11,5	6	M3	5	2	200
4049 08	8	4,5	11,5	6	M3	11	3	200
4049 10	10	4,5	11,5	6	M3	20	4	200
4049 13	13	4,5	11,5	6	M3	40	6	200
4049 16	16	4,5	11,5	6	M4	60	7	200
4049 20	20	6	13	8	M4	90	16	200
4049 25	25	7	14	8	M4	150	28	200
4049 32	32	7	15,5	10	M5	220	47	200

## SMCO Flat gripper

Flat pot SmCo, galvanized

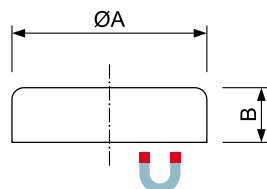

Item-Nr.	Dimension (mm)		Holding power (N)	Weight (g)	Temperature (°C)
	ØA	B			
4050 06	6	4,5	5	1	200
4050 08	8	4,5	11	2	200
4050 10	10	4,5	20	3	200
4050 13	13	4,5	40	4	200
4050 16	16	4,5	60	7	200
4050 20	20	6	90	14	200
4050 25	25	7	150	26	200
4050 32	32	7	220	42	200

## ACCESSORIES Flat gripper

Rubber-lip available as a protective coating for flat gripper with hole

Item-Nr.	Dimension (mm)			
	ØA	B	C	ØD
4052 052	52	6	0,5	-
4052 059	59	6	0,5	-
4052 065	65	8	0,5	-
4052 083	83	11	0,5	-
4053 050	52	6	0,5	20
4053 063	65	8	0,5	20
4053 080	83	11	0,5	24
4053 104	104	12	0,5	34

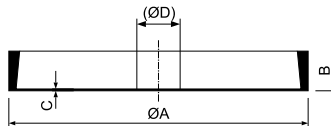

## NDFEB Rubber sheath Flat gripper

Flat Gripper in NdFeB, rubber sheath, black with threaded bush

Item-Nr.	Dimension (mm)				Thread (M)	Holding power (N)	Weight (g)	Temperature (°C)
	ØA	B	C	ØD				
4054 12	12	7	14,8	8	M4	10	6	60
4054 22	22	6	11,5	8	M4	50	13	60
4054 31	31	6	11,5	8	M4	75	22	60
4054 43	43	6	10,5	8	M4	85	30	60
4054 66	66	8,5	15	10	M5	180	105	80
4054 88	88	8,5	17	12	M8	420	192	80

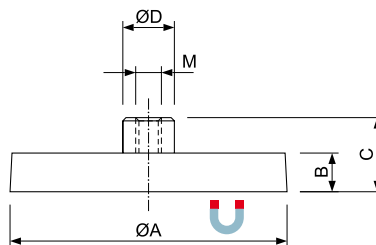

## NDFEB Rubber sheath Flat gripper

Flat Gripper in NdFeB, rubber sheath, black with threaded pin

Item-Nr.	Dimension (mm)			Thread (MxL)	Holding power (N)	Weight (g)	Temperature (°C)
	ØA	B	C				
4055 22	22	6	12,5	M4 x 6,5	50	11	60
4055 43	43	6	21	M6 x 15	85	32	80
4055 66	66	8,5	23,5	M8 x 15	180	107	80
4055 88	88	8,5	23,5	M8 x 15	420	193	80

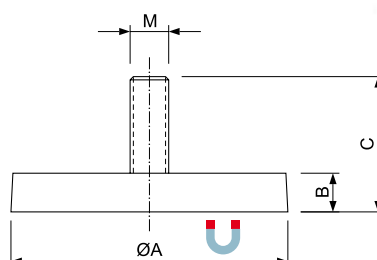



## NDFEB Rubber sheath Flat gripper

Flat Gripper in NdFeB, rubber coat black



Item-Nr.	Dimension (mm)		Holding power (N)	Weight (g)	Temperature (°C)
	ØA	B			
4056 22	22	6	50	9,5	60
4056 31	31	6	75	25	60
4056 43	43	6	85	28	60

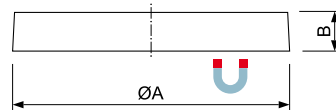

## NDFEB Rubber sheath Flat gripper

Flat Gripper in NdFeB, rubber sheath, black with cylinder bore



Item-Nr.	Dimension (mm)						Holding power (N)	Weight (g)	Temperature (°C)
	ØA	B	C	ØD1	ØD2				
4057 22	22	6	3,5	4	8,2	35	8	60	
4057 31	31	6	3,5	6	9	75	20	60	
4057 43	43	6	4,2	7	12,8	85	27	60	
4057 57	57	7,6	3,3	8	25,3	175	77	60	
4057 66	66	8,5	3,2	5,5	25	210	100	60	

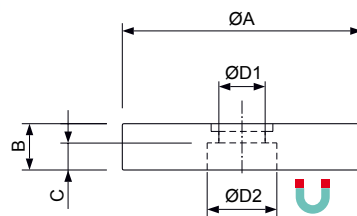

## NDFEB Rubber sheath Flat gripper

Flat Gripper in NdFeB, rubber coat with internal thread



Item-Nr.	Dimension (mm)		Thread (M)	Holding power (N)	Weight (g)	Temperature (°C)
	ØA	B				
4058 22	22	6	M4	35	9	60
4058 31	31	6	M5	75	21	60
4058 43	43	6	M4	85	29	60
4058 66	66	8,5	M6	180	100	80
4058 88	88	8,5	M6	420	186	80

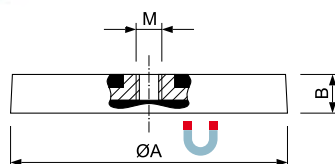

**Hint:**  
 Rubber sheathed flat pot bring maximum support against pushing forces and can be used on painted metal surfaces without damaging the surface.

## NDFEB Gripper Magnet

Neodymium magnetic grip, nickel-plated. Powerful, handy magnet for versatile use.

Item-Nr.	Dimension (mm)		Holding power (N)	Weight (g)
	ØD	H		
4060 12	12	16	55	7
4060 16	16	34	100	15
4060 28	28	68	180	28



## NDFEB Magnetic Foil

Multi-pole-magnetized NdFeB tighten up and down. Therefore, they are particularly well suited to sheet metal parts such as to attach signs. The magnetic films can be cut with a knife and placed in the form.

Select the version painted with adhesive foil to install magnetizable parts on a nonmagnetizable ground like concrete. Select the version unpainted without adhesive foil to connect two magnetizable surfaces or parts together.

### Magnetic foil painted with adhesive foil

Item-Nr.	Dimension (mm)			Holding power (N)	Weight (g)	Temperature (°C)
	L	W	H ±0,3			
4063 0100	203	97	3,8	200	260	75
4063 0101	227	97	3,5	200	300	75
4063 0102	227	37	3,5	200	120	75



### Magnetic foil unpainted without adhesive foil

Item-Nr.	Dimension (mm)			Holding power (N)	Weight (g)	Temperature (°C)
	L	W	H ±0,2			
4063 0200	203	97	3,8	200	260	75
4063 0201	227	97	3,5	200	300	75
4063 0202	227	37	3,5	200	120	75

## NDFEB Magnetic Strips

NdFeB magnetic strips achieve by their long detention areas best holding forces even with thin materials. They are ideally suited to attach signs and strips.



Item-Nr.	Dimension (mm)			Drilling (mm)	drilling-distance (mm)	Holding power (N)	Weight (g)	Temperature (°C)
	L	W	H					
4062 0030	30	13,5	5	1 x Ø3	-	90	13	80
4062 0035	35	24,5	7,5	1 x Ø3	-	300	14	80
4062 0040	40	13,5	5	2 x Ø3	30	120	16	80
4062 0050	50	13,5	5	2 x Ø3	30	150	21	80
4062 0100	100	13,5	5	2 x Ø3	60	310	42	80

## NDFEB Rubber-coated Magnetic Block

The super strong NdFeB magnet block is entirely elastomer coated to protect against corrosion and nickel on the rake. For mechanical recording a VA - receiving block is constructed with M10 thread. The NdFeB magnet block can be used as holding and mounting magnet even under harsh conditions.

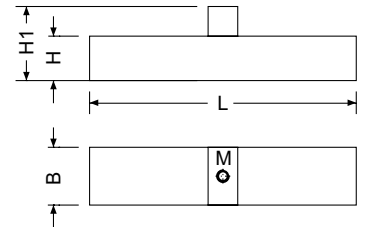

Item-Nr.	Dimension (mm)				mounting thread	Holding power (kN)	Weight (kg)
	L	W	H	H 1			
6 1000 0067	180	39	30	50	M10 x 20mm	3	1,5

## ALNICO Horseshoe Magnet

Horseshoe magnet AlNiCo, painted red

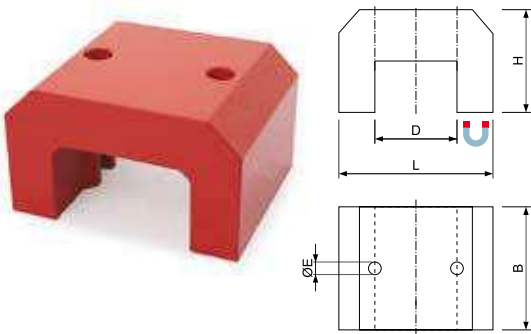

Item-Nr.	Dimension (mm)					Holding power (N)	Weight (g)	Temperature (°C)
	L	B	H	D	E			
4020 01	31	20	20	15	Ø4	45	65	450
4020 02	40	25	25	20	Ø5	90	150	450
4020 03	45	30	30	22	Ø6	120	220	450
4020 04	57	44,5	35	35	2 x Ø8	230	380	450
4020 05	71	57	41	41	2 x Ø8	320	1600	450
4020 06	78	82	54,5	48	2 x Ø11	470	2000	450

## ALNICO Button Magnet

Button magnet AlNiCo, painted red

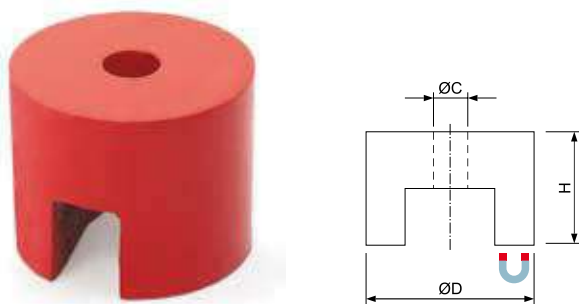

Item-Nr.	Dimension (mm)			Holding power (N)	Weight (g)	Temperature (°C)
	L	W	H			
4021 13	13	10	4,2	7	7	450
4021 19	19	13	5,4	19	20	450
4021 25	25	16	5,4	29	56	450
4021 32	32	25	7	66	133	450

## ALNICO Flat pot Magnet

Flat pot magnet made of AlNiCo, painted red



Item-Nr.	Dimension (mm)			Holding power (N)	Weight (g)	Temperature (°C)
	ØD	H	drilling-Ø (mm)			
4061 19	19	8	3,5	30	18	450
4061 29	28,6	9,5	6	55	46	450
4061 38	38	10,5	5	95	97	450

# Magnetic Gripping and Holding

## Metal Plate with Hole

Metal plate with hole and countersink, as a counter unit for flat gripper

Item-Nr.	Dimension (mm)		drilling Ø (mm)	Material	Weight (g)
	ØD	H			
4090 12	12	2	4	galvanized	1,5
4090 17	17	2	6	galvanized	4
4090 23	23,7	1,5	5	nickel	5
4090 27	27	3	5,5	stainless steel	12
4090 28	27	3	5,5	galvanized	12
4090 34	34	3	5,5	galvanized	20
4090 45	45	2	6,2	stainless steel	24
4090 46	45	3	5,5	galvanized	36
4090 64	64	3	5,5	galvanized	65



## Metal Plate with Adhesive Foil

Metal plate with adhesive film, as a counter unit for flat gripper

Item-Nr.	Dimension (mm)		Material	Weight (g)
	ØD	H		
4091 20	20	2	galvanized	6
4091 21	20	2	painted white	6
4091 30	30	2	galvanized	12
4091 31	30	2	painted white	12
4091 40	40	2	galvanized	20
4091 41	40	2	painted white	20
4091 60	60	2,5	galvanized	52
4091 61	60	2,5	painted white	52



## MARBLE-MAG

Marble-Mag advertising and organization magnets are extremely strong neodymium balls made with high quality nickel-plated surface. A ball with 8mm diameter holds as loose on a whiteboard up to 10 pages 80gr. Paper. For your customers, we pack 10 Marble-Mags in a transparent tube made from environmentally friendly plastic. The tubes of the Marble-Mags can be personalized with your logo, company address or advertising content be printed and are an ideal and functional advertising for your company. The maximum Size of 1-colored Screen printing is 65 x 27mm. After receiving your data we can offer the finished Marble-Mags within supply of 6-8 working days.

Item-Nr.	Dimension (mm)			Weight (g)
	ØD	L	Ball Ø	
8001 0001	14	100	8	20



## PERMANENT Raw Magnets

Permanent magnets are used for various applications in all areas. Depending on the requirements, the optimum Raw-magnet and the right surface coating should be selected.

Motors, generators, sensors - almost everything that moves is based on magnetism!



The following magnetic materials are used in the industry:

### 1. NdFeB

is the most powerful, commercially available permanent-magnetic material.

Main alloy constituents are neodymium, and boron ferrite.

His BH max. is 10 times higher than in ferrite. It is extremely hard magnetic - so immune to accidental demagnetization. The maximum operating temperature for NdFeB is 230°C. NDFEB magnets are very susceptible to corrosion and are therefore usually coated.

### 2. Ferrit Magnets

Main alloy constituents are ferrite, strontium and barium.

Ferrite magnets reach only comparatively small magnetic forces, but have the advantage to be very inexpensive.

They are not prone to corrosion and can be used at ambient temperatures up to 400°C. Ferrite magnets are the most used.

### 3. SmCo

Main alloy constituents are samarium and cobalt.

For the limited reserves of samarium and cobalt, SmCo magnets are very expensive. SmCo Magnets reach very high magnetic forces, only about 20% lower than the NdFeB magnets.

Very advantageous is the good temperature resistance. The ambient temperatures up to 300°C allow a reliable coercivity and very low susceptibility to corrosion. A disadvantage the brittle structure and the poor machinability should be mentioned.

### 4. AlNiCo

Major alloying constituents are aluminum, nickel and cobalt.

Alnico magnets (aluminum - nickel-cobalt) are the oldest technology used permanent magnets.

They achieve good magnetic holding forces about 30 % of NdFeB magnets and can be used at ambient temperatures up to 550°C. Alnico magnets are extremely hard and brittle and, due to the cobalt content are relatively expensive.

Magnetization directions

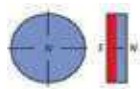

Magnetized axially

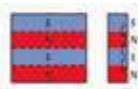

Magnetized in strips

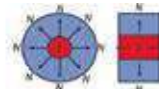

Magnetized radially



Magnetized radially

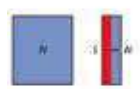

Magnetized in the Height

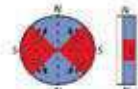

Multipole magnetized on circumference

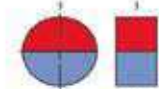

Magnetized diametrically

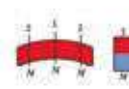

Magnetized diametrically

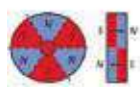

Axial sector-shaped magnetized 6 pins

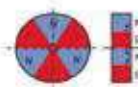

Sector-shaped in an area magnetized 6 pins



Multipolar magnetized on the inner circumference

## NDFEB Magnets

Neodymium magnets of the highest quality, we offer you in the qualities of N28-N55 to for working temperature ranges up to 230°C. Here are some examples of magnetic parameters for magnets in the working temperature range up to 80°C.

For further information please ask for our ND-Catalog.

Type	Br T (kGS)		Hcb kA/m kOe	Hcj kA/m kOe	BH max. kJ/m <sup>3</sup> MGOe		Temperature (°C)
	Max.	Min.			Max.	Min.	
N54	1,5	1,47	<835	<875	430	410	<70
	15	14,7	<10,4	<11,0	54	51,5	
N52	1,48	1,44	<876	<955	414	394	<80
	14,8	14,4	<11,0	<12,0	52	49,5	
N50	1,45	1,41	<876	<955	398	382	<80
	14,05	14,1	<11,0	<12,0	50	48	
N48	1,42	1,36	<876	<955	382	358	<80
	14,2	13,6	<11,0	<12,0	48	45	
N45	1,37	1,33	<876	<955	358	334	<80
	13,7	13,3	<11,0	<12,0	45	42	
N42	1,33	1,29	<876	<955	334	318	<80
	13,3	12,9	<11,0	<12,0	42	40	
N40	1,29	1,26	<876	<955	318	303	<80
	12,9	12,6	<11,0	<12,0	40	38	
N38	1,26	1,22	<876	<955	303	287	<80
	12,6	12,2	<11,0	<12,0	38	36	
N35	1,22	1,17	<876	<955	287	263	<80
	12,2	11,7	<11,0	<12,0	36	33	

## NDFEB Magnets

Neodymium magnets have to be surface-treated to protect against corrosion. In general, the magnets are coated. Especially for motor magnets but also recommended the process of passivation by heat treatment.

The most common coatings are nickel, zinc and epoxy resin. The coatings have the following properties.

Coating type	Coating thickness	Color	Temperature	Salt Spray Test	Pressure Cooker Test	Rating
Nickel	10 - 30 µm	bright silver	< 200 °C	> 96 h	> 48 h	Good protection against Corrosion, even at higher temperatures. High protection against abrasion of the coating
Zinc	5 - 10 µm	dark silver	< 160 °C	> 48 h	0	Sufficient for installation sheet turns into a little aggressive environments
Epoxid-resin	10 - 30 µm	dark grey	< 120 °C	> 500 h	0	Best resistance to corrosion, poor protection against abrasion of the coating.

NdFeB magnet materials are produced in a press - sintering process and machined after the sintering process to produce the desired shape.

Rare earth magnets are very brittle and not easy to work with. The higher is the maximum operating temperature of the material, the more brittle the material.

The table below lists the physical properties of NdFeB standard material.

Signs	Parameter	Unit	Defaults
(Tc)	Curie-Temperature	°C	310 - 380
(Tw)	max. Operation-temperature	°C	80 - 230
(HV)	Hardness	HV	620
(ρ)	electrical resistance	Ω Ohm	180 - 200
(D)	Density	g/cm <sup>3</sup>	7.45 - 7.65
(μ rec)	Recoil Permeability		1.05
(Hs)	Magnetic field Strength	kOe kA/m	>30 >2400
(βBZ)	Bending Strength	MPa	295 - 345
(Br)	Temp. Factor Br	%/°C	-0.11 ~ -0.12
(Hcj)	Temp. Factor Hcj	%/°C	-0.5 ~ -0.7

## INSTALLATION INSTRUCTIONS for Permanent Magnets

Iron poles have resulted in improved power line density in the magnetic circuit. This leads to a significantly improved adhesion, as redirecting the magnetic flux and can concentrate on the adhesive surface. An approximate increase factor for the lifting capacity is given in the illustrated drawings.

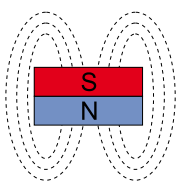

Open magnetic core as Discs or bars without Affected by iron poles  
100 %

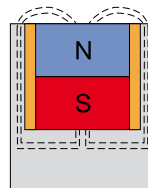

Magnetic wand made of AlNiCo in iron sleeve  
750%

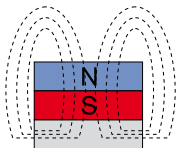

With Iron yoke plate  
130%

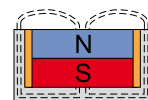

Magnetic-plate in U-Angle made of iron  
550%

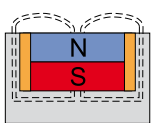

Magnetic slice in iron pot  
600%

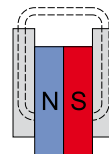

Sandwich from a magnetic disk between 2 flat iron poles  
1800 %

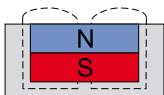

Non-magnetisable material

**Incorporation of magnetic cores:**  
A magnetic short circuit is formed when the two magnetic poles are connected by iron. Connections should therefore be made of non-magnetisable materials such as brass or stainless steel.



Magnetisable material

### Material-dependent holding force

Material	Holding performance (%)
Carbon steel 0,1 - 0,3 % C	100
Carbon steel 0,4 - 0,5 % C	90
alloy Steel F-522	80 - 90
cast iron	45 - 60
stainless steel	0
Brass, Aluminum, Copper	0

### Holding force at respective surfaces

Surface	Holding performance (%)
Raw steel	50
roughed	70
settled	90
polished	100

## PERMANENT Raw Magnets

An important quality of NdFeB magnets is their dimensional stability, since, depending on the form of some tolerances are very difficult to comply with. You see, if possible, in the construction of unnecessary tight tolerancing from. This will facilitate the installation of the magnets.

Below you will find our standard tolerances for the most common magnetic shapes:

Dimensions (mm) Blocks	Tolerance (mm)	Parallelism (mm)
L ≤ 10	± 0,03	0,04
L 10 - 30	± 0,05	0,06
L 30 - 50	± 0,08	0,08
L ≥ 50	± 0,1	0,1



Dimensions (mm) Slices	Tolerance (mm)	Parallelism (mm)
D ≤ 10	± 0,02	0,03
D 10 - 30	± 0,03	0,03
D ≥ 30	± 0,04	0,04



Dimensions (mm) Rings	Tolerance (mm)	coaxiality (mm)
d ≤ 10	± 0,04	0,06
d 10 - 30	± 0,05	0,06
d 30 - 50	± 0,06	0,08
d ≥ 50	± 0,08	0,1



Segments	Dimensions (mm)	Tolerance (mm)
Thickness	T ≤ 10	± 0,04
	T 10 - ≥ 30	± 0,05
Length	L ≤ 10	± 0,03
	L 10 - 30	± 0,05
	L 30 - 50	± 0,08
	L ≥ 50	± 0,1
Chord length	W ≤ 10	± 0,05
	W ≥ 50	± 0,06





**ACCESSORIES**

In the following chapter, you will find accessories such as demagnetizing devices and measuring instruments Magnetic systems.



**Page 178 - 180**

**Demagnetizing Devices**



**Page 181**

**HGF Handgaussmeter**

### DEMAGNETIZER

---

Demagnetizer Remove unwanted magnetism from workpieces and tools. Unintentional Magnetism may remain in parts that have been exposed deliberately or accidentally to a magnetic field. In Practice, these are mostly tools, vices and small workpieces, but also great tool plates. The tougher and harder a material, the more prone he is due to its dense surface structure for the preservation of residual magnetism. In magnetized workpieces and permanent magnets, the molecules of the material are aligned in one direction. Under demagnetization is understood that this alignment is eliminated. You reach that by the workpiece exposing a decreasing alternating magnetic field. In practice, this is realized by

### PLATE-DEMAGNETIZER

---

In the case of plate demagnetizing devices, the workpiece is guided slowly over the pole surface at a constant speed and thereby demagnetized. For large workpieces that are difficult to handle, hand tools are used, which are guided over the workpiece like an iron.



### TUNNEL-DEMAGNETIZER

---

Tunnel demagnetizers are mainly used in conjunction with conveyor belts. The workpiece must be guided through the tunnel at a constant speed.



To select the right demagnetizer for automated application, the following information is required: material dimension, material composition, material strength and required speed. A wide range of standard equipment is available for small series and individual parts.

## DM Plate-Demagnetizer

DM plate demagnetizers are high-quality, modern devices with 100% duty cycle and one Unique system which adjusts the field intensity of the size or the volume of the workpiece, whereby a low standby consumption and a high demagnetization quality are achieved. DM demagnetizing devices can also be used as an under- or overband device. The workpieces are guided over the pole plates by hand or by conveyor belt. Mass parts can be collected in a non-magnetic container and guided over the pole surfaces.



Model	Item-Nr.	Pole area (mm)	Height (mm)	Weight (kg)	ED	Performance (W)
DM 3	3010 2518	250 x 180	86	11	100%	350
DM 4	3010 2827	281 x 266	86	14	100%	350
DM 5	3010 4030	401 x 306	86	19	100%	350

Other dimensions and special versions on request!



## DMS Plate-Demagnetizer

DMS plate demagnetizers are classically stable, powerful and cost-effective devices for the occasional use. They are mainly used in tool and fixture construction. The workpieces are simply guided over the pole plates by hand. Mass parts can be collected in a non-magnetic container and guided over the pole surfaces.



Item-Nr.	Pole area (mm)	Height (mm)	Weight (kg)	ED	Performance (W)
9010 1612	160 x 120	115	5,5	10 min.	300
9010 2217	220 x 170	122	12	10 min.	660
Other dimensions and special versions on request!					

## TUNNEL Demagnetizer

Tunnel demagnetizers are used in automated and semi-automated work processes as well as demagnetizing pipes, rods, etc. The workpieces must be guided through the tunnel at a constant speed.

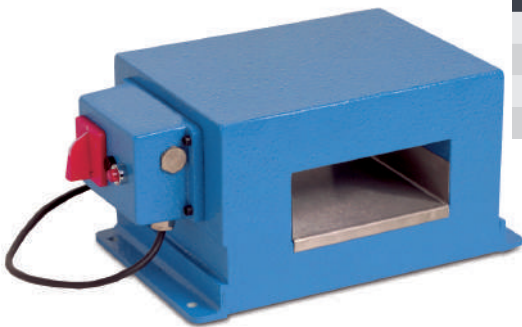

Item-Nr.	Tunnel hole (mm)	external dimensions (mm)	Weight (kg)	ED	Performance (VA)
9011 1560	150 x 60	200x250x160	27	100%	870
9011 2010	200 x 100	200x330x230	45	100%	2300
9011 4020	400 x 200	570x370x350	115	100%	3500
Other dimensions and special versions on request!					

## HAND Demagnetizer

Hand Demagnetizers are used for the demagnetization of large parts or workpieces which can not be guided to the device for other reasons, eg: injection molds, punching tools, built-in vices, clamped tools, etc.



Item-Nr.	Pole area (mm)	Height (mm)	Weight (kg)	ED	Performance (VA)
9012 1210	120 x 100	180	5,5	10 min.	1300

## HANDTESLAMETER

The HGF Handgausmeter is an easy to use precision instrument. The superfine 1mm probe magnetic flux densities can be measured extremely close to the magnetic pole and in very narrow air gaps. The HGF can be switched between AC and DC magnetic fields as well as between units Gauss and Tesla. At the edge of the display the pending polarity N/S is in the mode „DC magnetic fields“ constantly displayed, the „peak indicator“ facilitates the search for magnetic surfaces for example, in tracking down unwanted residual magnetism.

The package includes in addition to the meter, the 1mm transversal probe and the batteries and a protective case and a protective cap for the probe. Thus, HGF is also suitable for use in the service industry. Our technicians use it for testing of heavy lifting magnets and clamping systems.



Included in delivery is a safe case storage



Model	Item-Nr.	Measuring range (GS)	Probe cable (m)	Dimension (mm)		
				L	W	H
Handteslameter	3018 0001	0 - 30.000	1	150	70	35
Replacement probe	3018 0001-1	0 - 30.000	1			

Your question, our recommendation! Please contact us regarding your specific application.  
Together we will find the right solution for you!

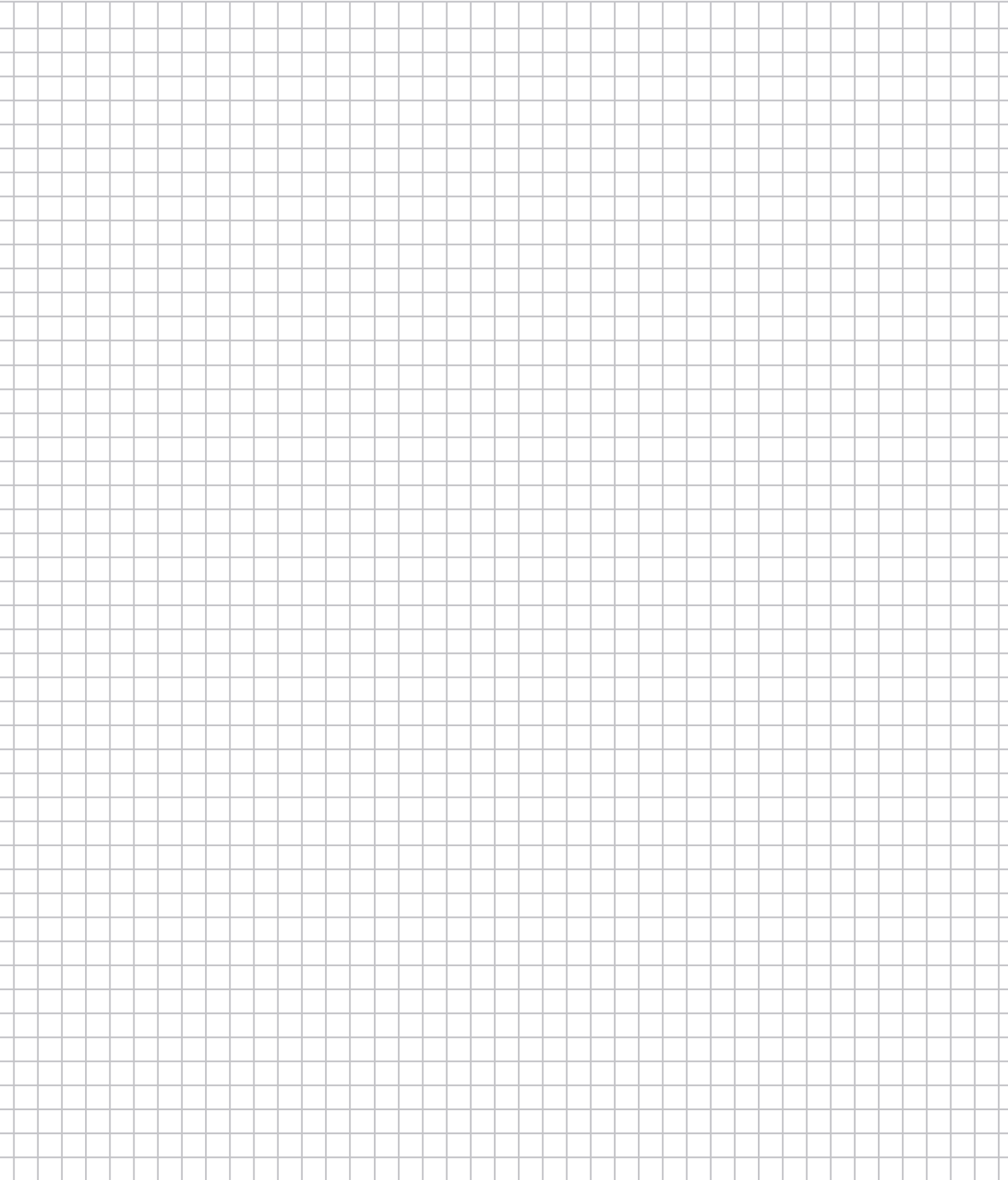

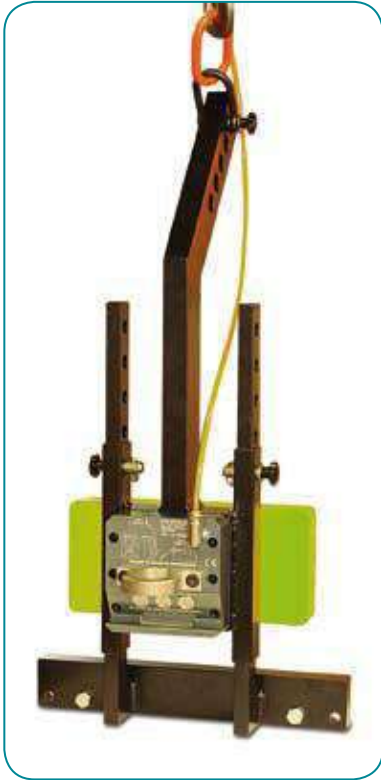



# MAGNETIC SOLUTIONS

**FAST • SAFE • PRODUCTIVE**

**FLAIG TE**  
*Magnetsysteme*

St. Georgener Straße 73  
D-78739 Hardt  
Tel +49 (0) 7422 / 940010  
Fax +49 (0) 7422 / 9400125  
info@flaig-te.de  
www.flaign-te.de



Valid from September 2016